

1/2" x  
mor

5/8" x 1"  
tises

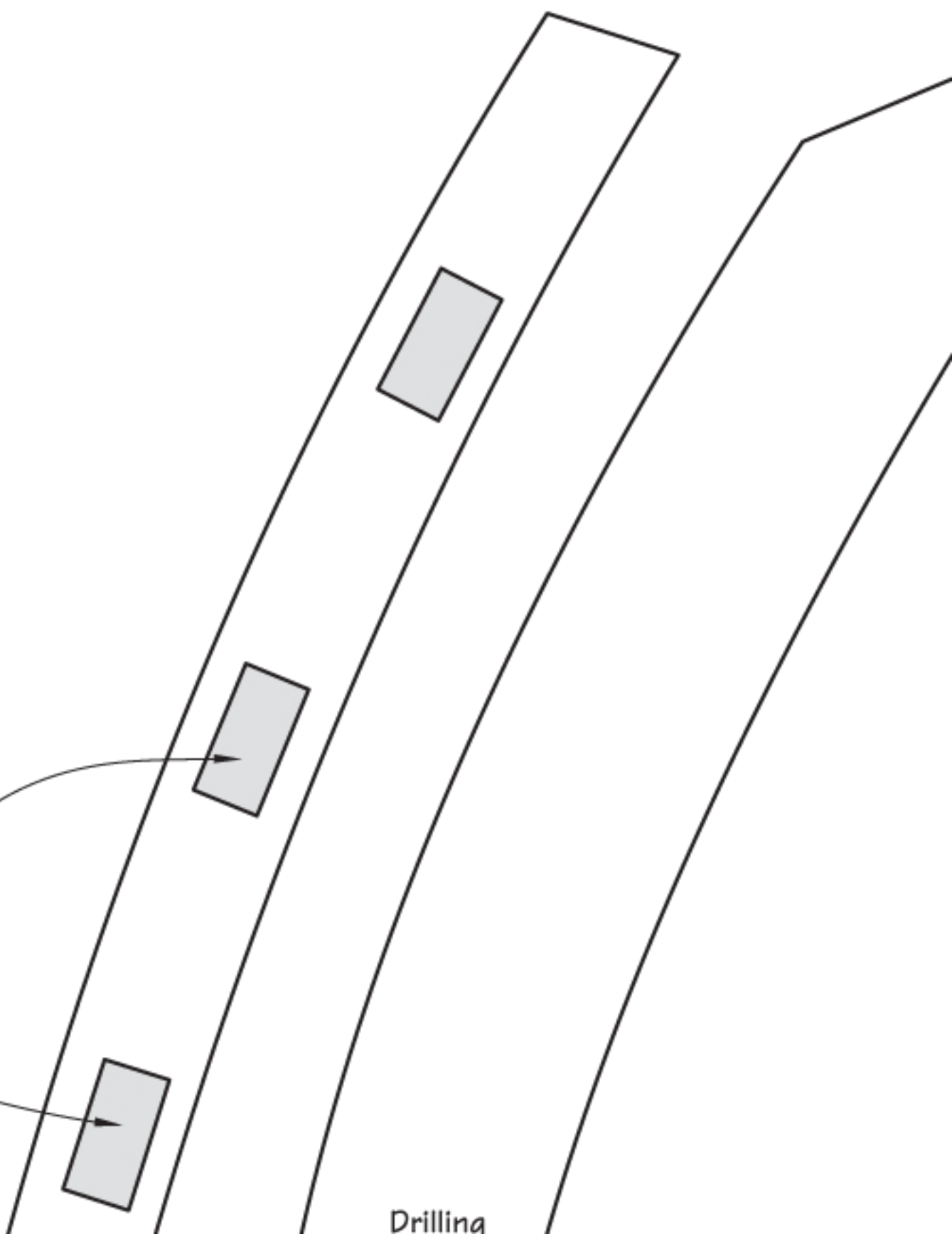

Drilling

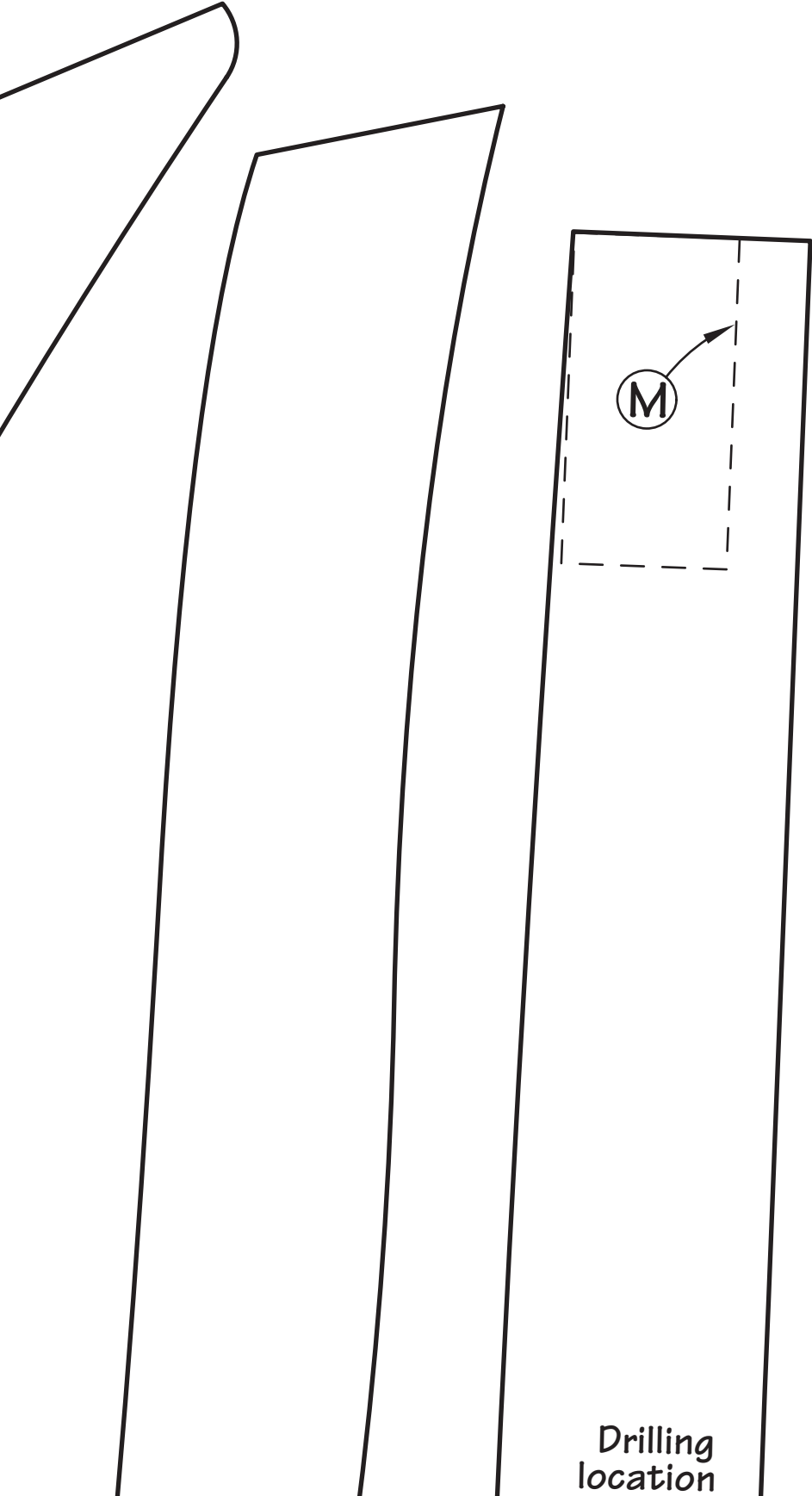

Drilling  
location

ⓐ

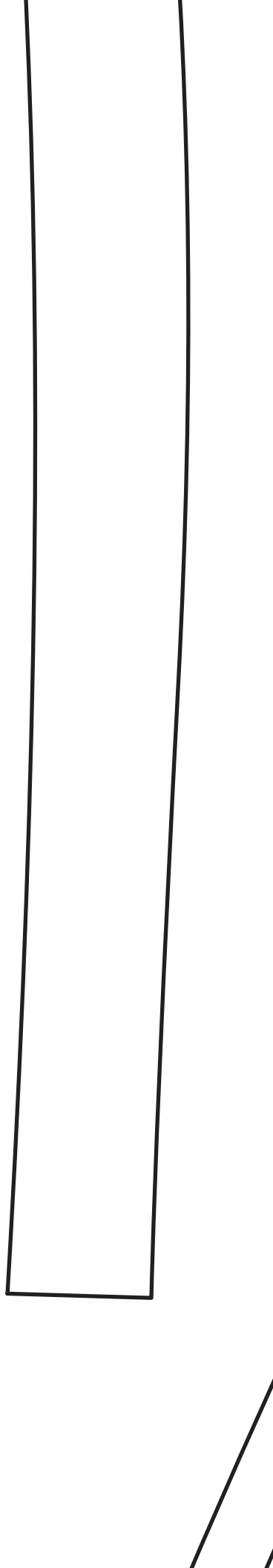

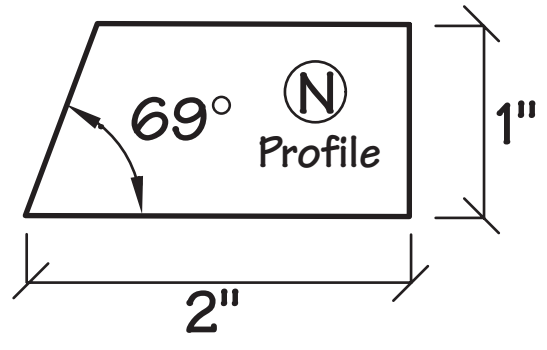
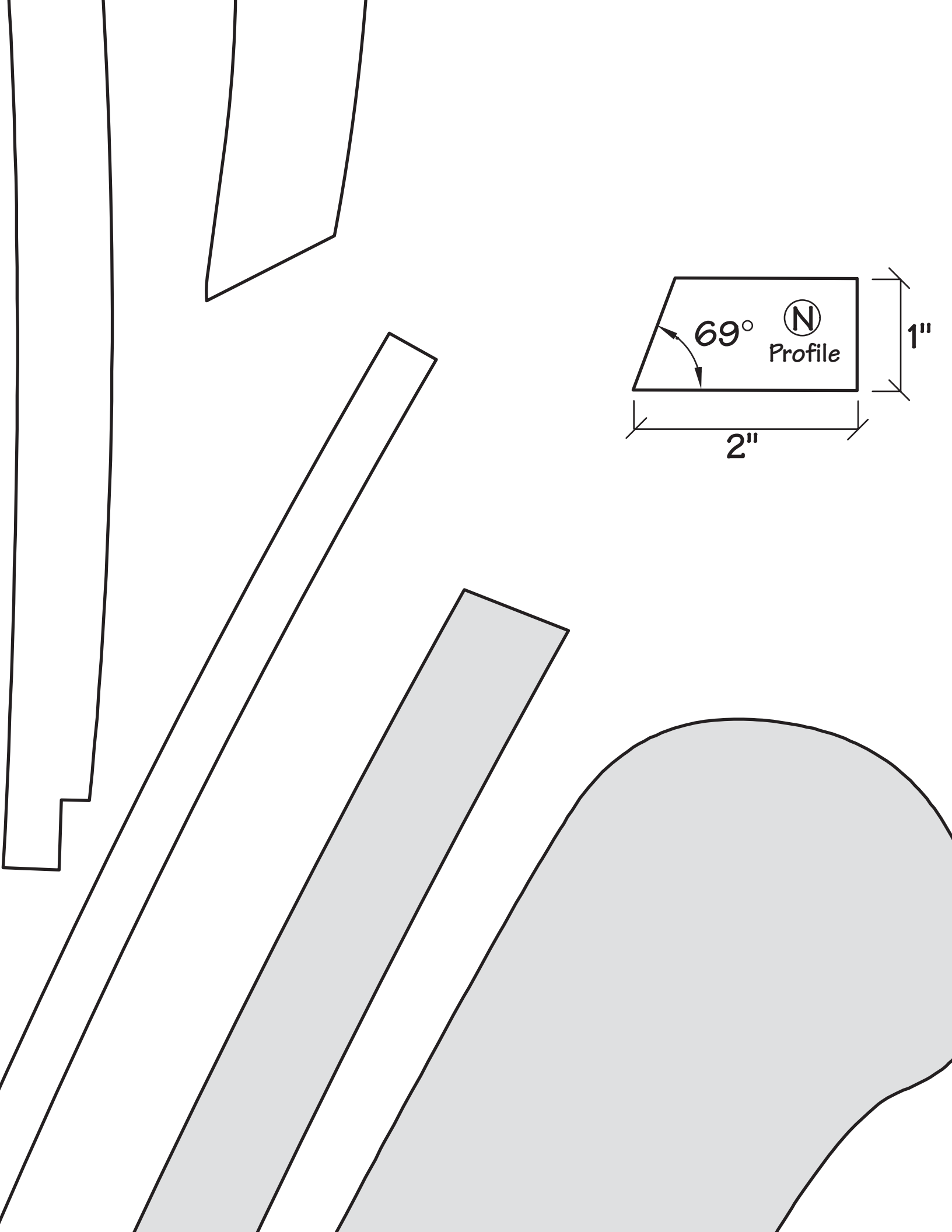

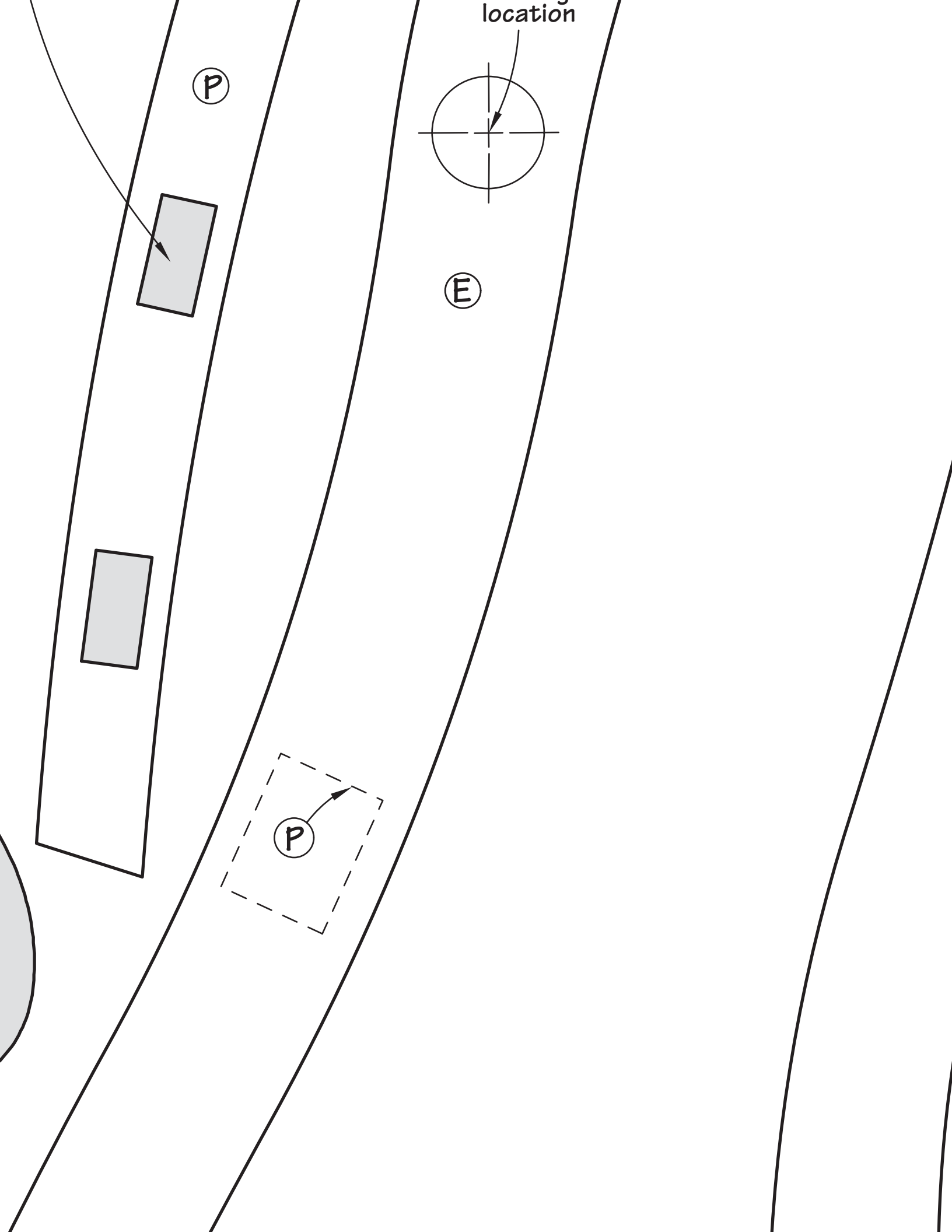

Ⓓ

Drilling  
location

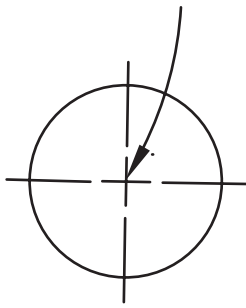

Ⓕ



Ⓗ



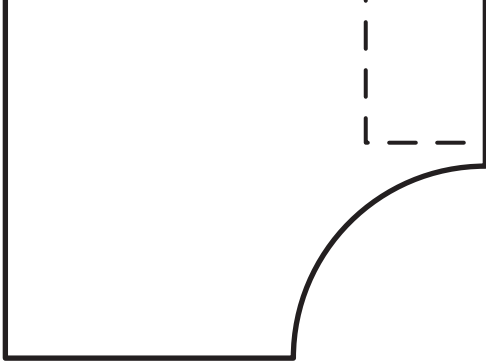

Q

B  
Plan

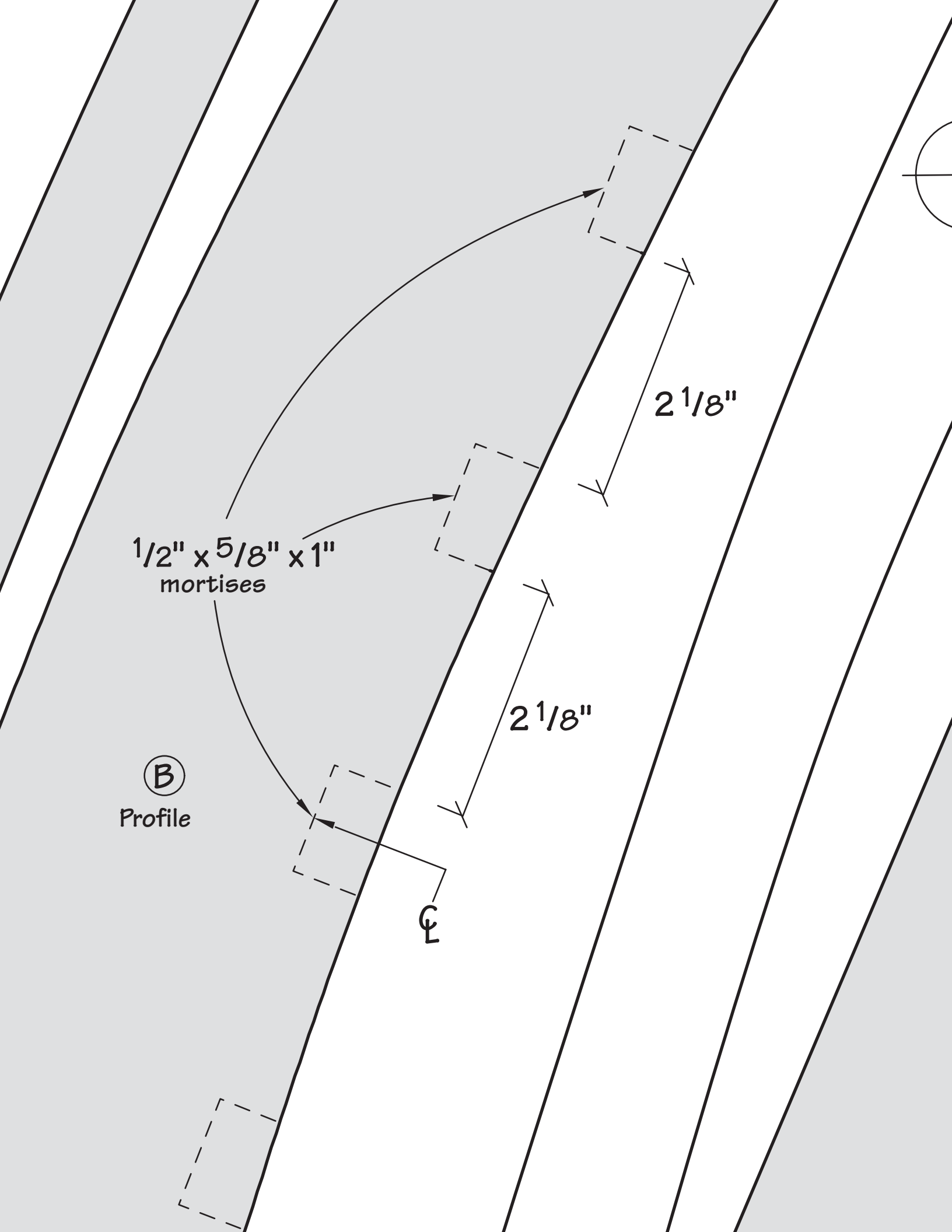

$1\frac{1}{2}" \times 5\frac{1}{8}" \times 1"$   
mortises

$2\frac{1}{8}"$

$2\frac{1}{8}"$

**B**  
Profile

**C**



Drilling location

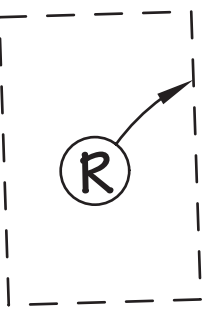
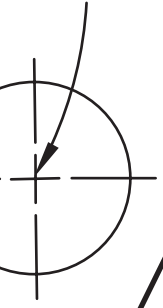

(A)  
Plan

(A)  
Profile

Locations for seat slats "U". Mortises are shaded.

(C)

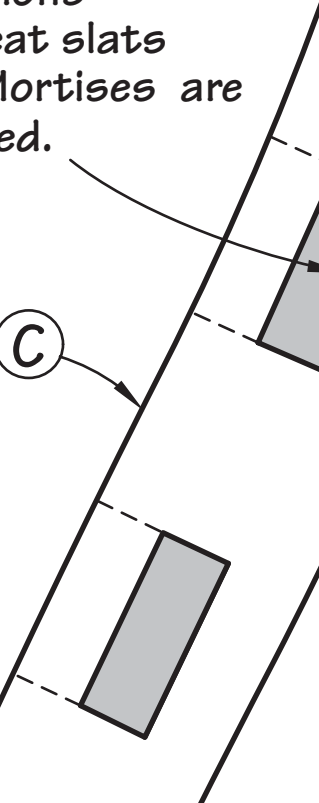

Drilling  
location

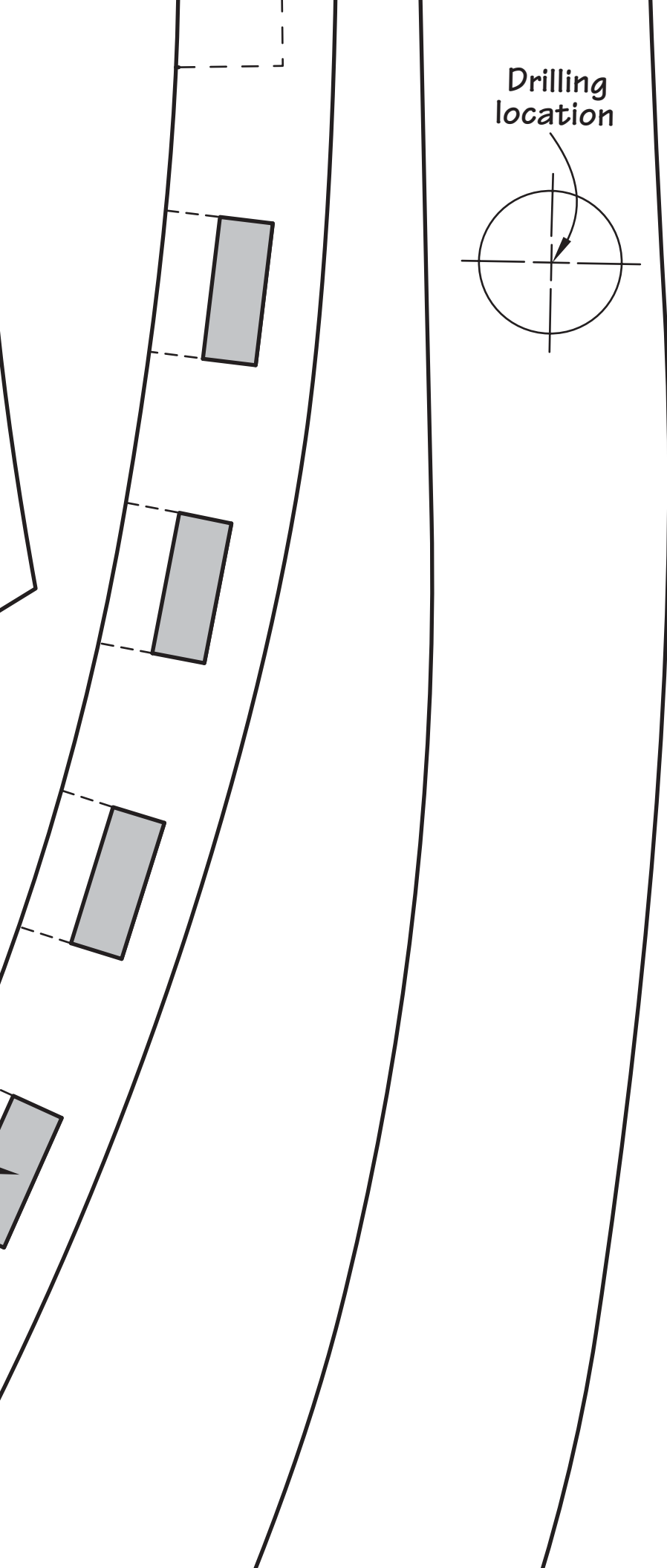
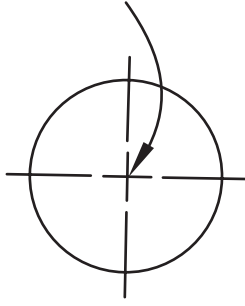

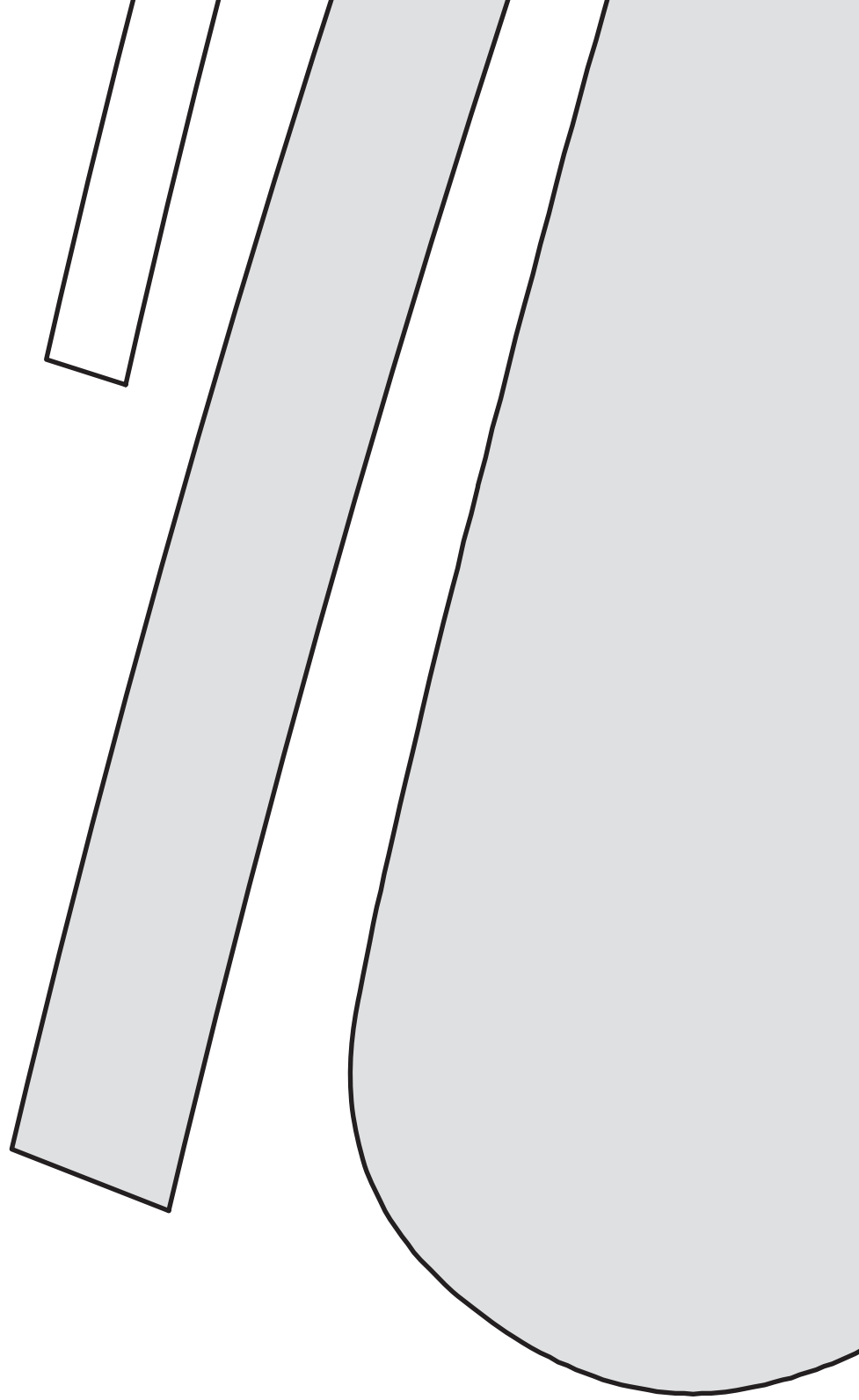

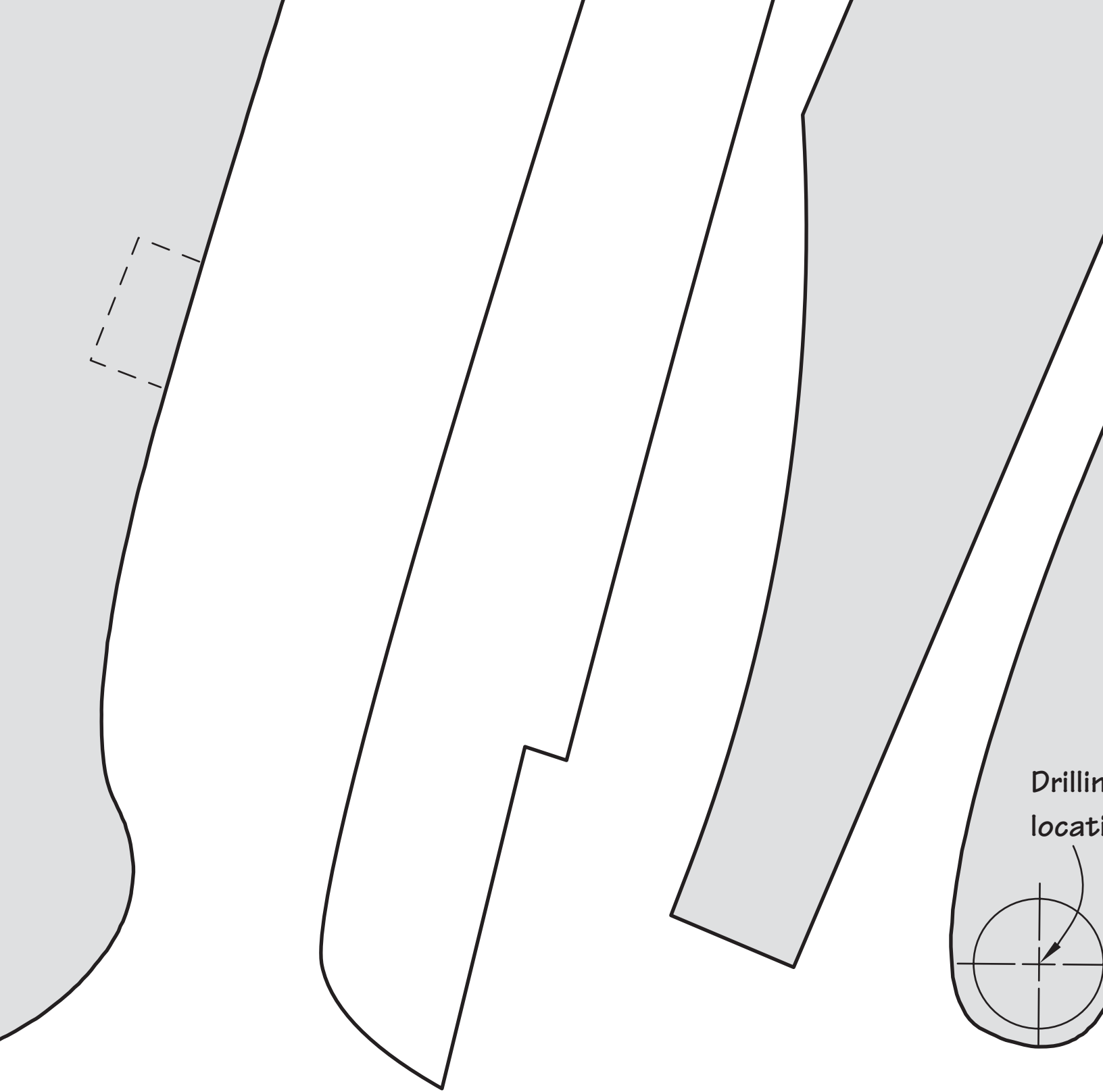

Drilling  
location

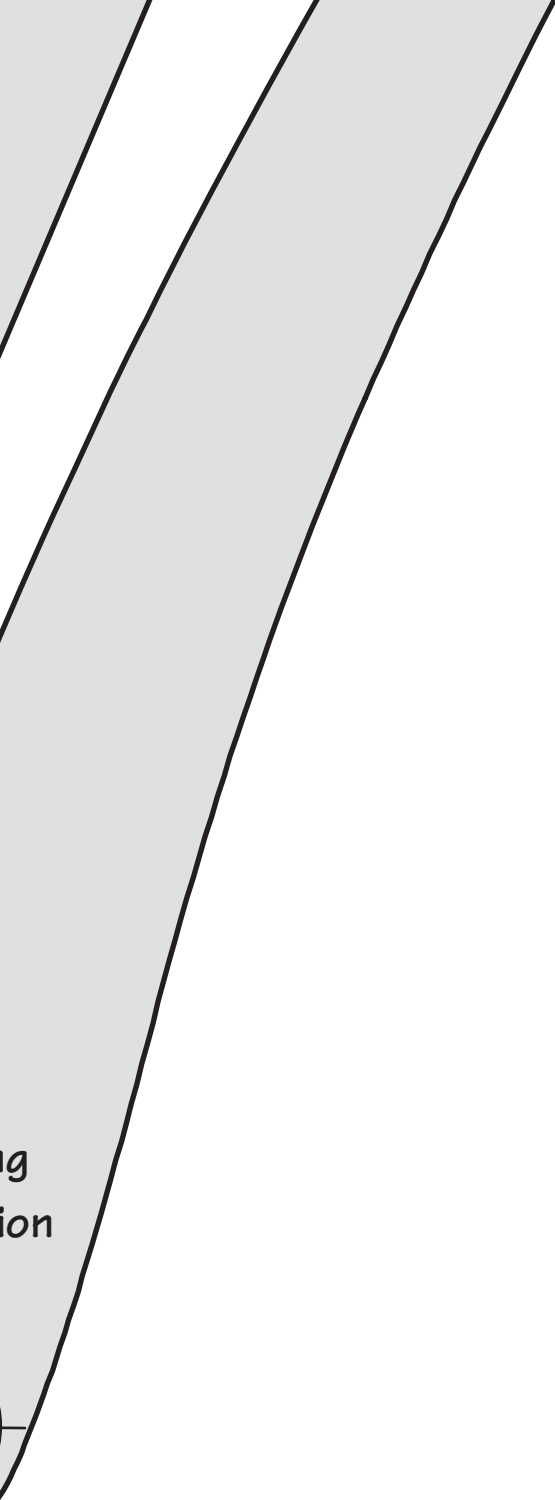

g  
ion

