



Learning to sharpen your edge tools will open up a lot of doors in woodworking. Sharpening is half the battle when learning handplanes, turning and carving.

Photos by Al Parrish

# Sharpening

---

## Plane Irons and Chisels

We've tried just about every sharpening system there is – from sandpaper to ceramics to waterstones. Here's how to get the best possible edge with the least amount of fuss.

When I took my first class in woodworking some years ago, the first thing the instructor showed us was his shop-made waterstone pond.

With a reverence and care reserved for religious artifacts and small injured animals, the teacher brought the pond out from its special place in his cabinet. For more than an hour he talked with a furrowed brow about secondary bevels, wire edges and polishing the back of our edge tools.

All of us in the class did our best to stifle our yawns. I kept looking at the rows of chisels and backsaws and wondered when we were going to get to the important part.

Within a week we all realized that we should have paid more attention to the sharpening lecture. Soon there were only two sharp chisels in the shop for a class of 10 students, and we quarreled over them. Trimming tenons with the equivalent of a butter knife was no fun.

So I made it a point to learn to sharpen well. And I've been fortunate to be able to use a variety of methods, including: oilstones, diamond stones, waterstones, ceramic stones, sandpaper, electric grinders and the Tormek system.

Each system has its good and bad points. Some are simple, others don't make a mess, some are less expensive and most systems can put an astoundingly good edge on tool steel.

For me, the two most important qualities a sharpening system needs are that it must be fast and it must produce the keenest edge. I'll pay a little more and suffer a little mess to get a good edge in a hurry.

That's because I'm more interested in woodworking than I am in the act of sharpening. I have no desire to look at my edges under a microscope or fret about tiny imperfections in the metal. I'm not the kind of guy who wants to meditate on my power animal as I proceed up to 500,000 grit. I want to be done with it and get back to the good part.

---

by Christopher Schwarz

Comments or questions? Contact Chris at 513-531-2690 ext. 1407 or [chris.schwarz@fwpubs.com](mailto:chris.schwarz@fwpubs.com).

## Familiarity Breeds a Keen Edge

The steps I'm about to describe will work with every sharpening and honing system I know of on the market. That's because no matter what system you use, sharpening is about one thing: Grinding and polishing the two intersecting planes of a cutting edge to as fine a point as possible.

The tools you use to get there are up to you. But here are a few words of advice: Pick a sharpening system and stick with it for a good long time before you consider giving it up. Many woodworkers that I've talked to jump around from system to system, trying to find the best thing (and spending a lot of money).

If you stick with one system, your edges will improve gradually as you get better and better at using your particular set of stones or sandpaper. Skipping around from one system to the next will only stunt your sharpening skills.

Second, please buy a honing guide. It's a big old lie that these things slow you down. In fact, these simple and inexpensive guides are quick to set up and ensure your edge will be perfect every time you sharpen.

However, don't buy a whole rolling army of honing guides. I

## GRINDING THE EDGE

To begin grinding your edge, put the tool in your honing guide and adjust it until the cutting bevel is flat on your stone. Eyeball it at first. After a couple passes on the stone you'll know if you're off or not.



Flat-grinding your cutting bevel should not take long on a coarse diamond stone. If you're having trouble gauging your progress, color the cutting bevel with a permanent marker and you'll get a quick snapshot of where you stand.

use a \$10 Eclipse-style guide (the gray-colored side-clamp contraption shown in most of the photos) for sharpening my chisels and most plane irons. I also own the Veritas honing guide. It

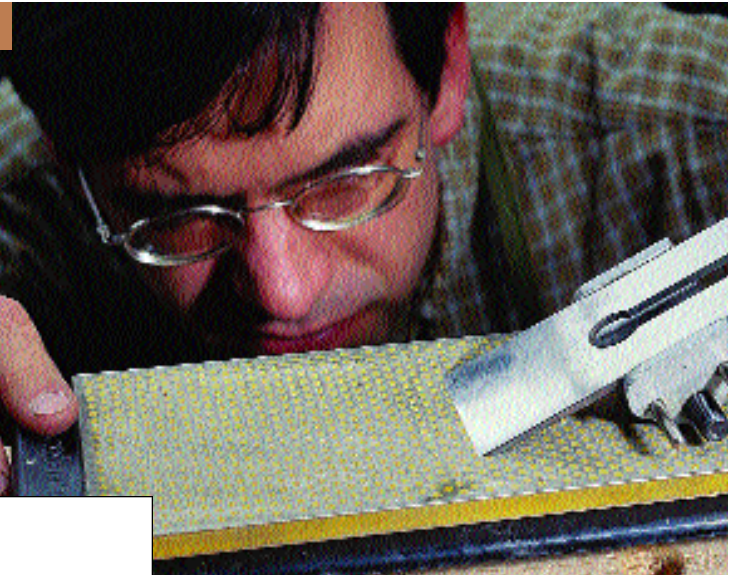

If you don't polish the backside of your newly acquired chisels and plane irons, your cutting edges will always be jagged and easily dulled. You need to polish just the area up by the cutting edge. This is a process you'll only have to do once.

excels at sharpening skew chisels and specialty plane irons that won't fit in the Eclipse guide, such as irons for shoulder planes.

Each honing guide holds the blade a little differently, and few of them are ever perfectly square. That's OK because what you're after with a honing guide is repeatability. Use the same guide over and over, and your edges will come out the same every time.

### Polish Your Backside

There are three sharpening operations that must be performed on all chisels and plane irons that are new to you. First you must polish the flat backside (sometimes called the "cutting face") of the tool. Next you grind the cutting bevel. Finally you hone and polish a small part of that cut-

ting bevel, which most people call the "secondary bevel."

Keep in mind that these three steps are only for tools that you have newly acquired. Once you do these three things, maintaining an edge is much easier. You'll probably only have to polish the backside once. You'll have to re-grind an edge mostly when you hit a nail or drop the tool. Most sharpening is just honing and polishing the secondary bevel.

Begin with the backside of the tool. This is the side of the tool that doesn't have a bevel ground into it. It's one-half of your cutting edge so you need to get it right.

Start sharpening by rubbing the backside back and forth across a medium-grit sharpening stone or sandpaper. You don't need to polish the entire back, just the

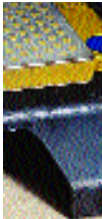
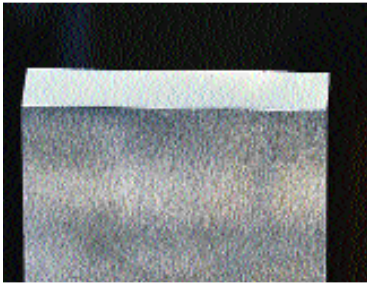

When you're done grinding, this is what your edge should look like.

area up by the cutting edge. I begin this process with a 1,000-grit Norton waterstone, then do the same operation with the 4,000-grit and then the 8,000-grit stone. The backside should look like a mirror when you're finished.

### The Not-so-daily Grind

The next step is to grind the cutting bevel of the tool. You can do this on an electric grinder that has a tool rest, which will produce a slightly curved cutting bevel called a hollow-ground edge. Or you can do it on a coarse sharpening stone, which will produce a flat-ground edge.

Lots has been written about the advantages and disadvantages of each system. In comparing my hollow-ground edges vs. flat-ground edges I personally have found little difference between them in terms of edge durability.

I grind using a diamond stone for three reasons. First, it will never destroy a tool due to overheating (which can happen with electric grinders). Second, I use the diamond stone to flatten the waterstones. And third, the diamond stone is great for touching up my router bits.

I use DMT's extra-coarse stone for grinding my edges (800-666-

4368 or dmtsharp.com). Put the tool in your honing guide and set it so the cutting bevel is dead flat against the stone. Most tools come ground at a 25° bevel, which is good for most woodworking tasks. Mortising chisels should be set for 30°; tools designed for light paring only can be set for 20°.

Don't get too worked up about angles as you begin sharpening. Somewhere in the 25° neighborhood will be fine for most tools.

I use mineral spirits to lubricate my diamond stone. Most people use water, but a sharpening guru at DMT turned me on to mineral spirits. It evaporates slower than water and won't allow rust to build up easily on the stone.

Rub the cutting bevel against the diamond stone and check your progress. You want to grind the entire cutting bevel of the chisel or plane iron all the way across. If you set the tool proper-

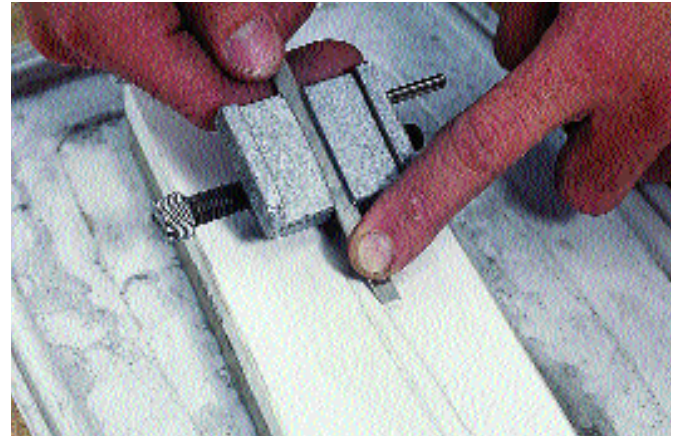

When honing narrow chisels, this is the best way I've found to keep things steady and square. Put one finger on the cutting edge; put the other behind the jig to move it.

ly in the jig, this should be about five to 10 minutes of work.

As you progress on this coarse stone, you should make a substantial burr on the backside of the tool. This is called a "wire edge," and you'll want to remove it by rubbing the backside on your finest-grit stone a couple times.

Never rub the backside on your coarse stone. That just undoes all your polishing work there.

How you hold the jig is important, too. For plane irons and wide chisels, put a finger on each corner of the tool up near the cutting bevel and use your thumbs to push the jig. For narrower chis-

## WHY I SWITCHED TO WATERSTONES

There are a lot of sharpening systems out there. And while I haven't tried every one of them, I've tried most. After much experimentation, I settled about five years ago on a system that used DMT diamond stones and oil-



Norton waterstones and the DMT DuoSharp stone are a great combination. The DMT handles the grinding jobs and flattens the Norton waterstones (800-446-1119 or nortonabrasives.com).

stones. My system worked pretty well, but the oilstone part was slow, and my final cutting edge was always "almost" perfect.

Last summer I got my hands on a set of Norton's new American-made waterstones and it was like a door had been opened for me. These things cut wicked fast. And the edge they produce is darn-near perfect.

They feel different than many Japanese waterstones I've used. The best way to describe the difference is that the Norton stones give you different "feedback" as you sharpen. The 4,000-grit Norton actually feels like it is cutting (it is). The 4,000-grit Japanese

stones I've used have a more rubbery feel to them in use in my opinion. And they didn't seem to cut as fast at that level. The 8,000-grit Norton waterstone also provides great feedback to the user.

The downside to all waterstones is that they need to be flattened regularly. For this job, I use a DMT DuoSharp stone with the coarse grit on one side and the extra-coarse on the other. I also use this same diamond stone for grinding the cutting edge of all my chisels and plane irons.

The most economical way to get started with this system is to buy a Norton combination waterstone that has 1,000 grit on one side and 4,000 grit on the other. Then buy an 8,000-grit Norton waterstone for polishing. Norton also makes a 220-grit waterstone, but if you buy the DMT diamond stone you won't need it.

— Christopher Schwarz

## HONING THE EDGE

Before you begin honing the secondary bevel, loosen the clamp on your honing guide and nudge the blade backward in the guide about  $\frac{1}{8}$ ".



After a dozen licks, turn the tool over and remove the burr from the backside by rubbing it a couple times over the 8,000-grit stone.

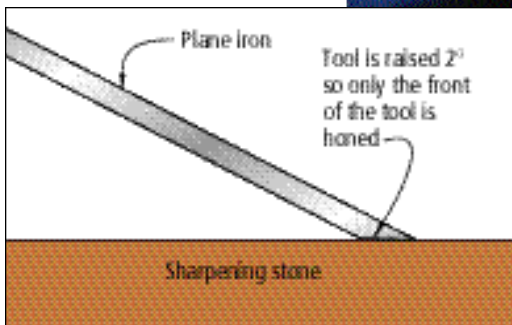

Begin with a 1,000-grit stone and rub the tool back and forth across the work. Try to wear the stone evenly by moving the tool in a regular pattern.

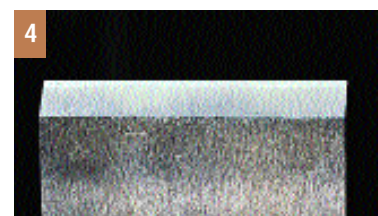

After honing the tool on the 1,000-grit stone, this is what the secondary bevel should look like.

els, put one finger on the tool by the cutting bevel and push the jig from behind with one finger.

With the cutting bevel ground, it's time to refine the leading edge to a keen sharpness.

### Honing: the Fun Part

Honing is quick and painless if your stones are flat and you've

done the first two steps correctly. The first thing to do is to reset the tool in your honing guide. Loosen the screw that clamps the tool and slide the tool backwards about  $\frac{1}{8}$ ". Retighten the screw.

This will set the tool so only a small part of the cutting bevel will get honed. This speeds your sharpening greatly.

Start honing with a 1,000-grit waterstone, soft Arkansas oilstone or 320-grit sandpaper. I use the 1,000-grit Norton waterstone. Lubricate your stones as recommended by the manufacturer. Rub the tool back and forth on the stone. Turn it over and check your progress. You should see a secondary bevel appear up at the cutting edge. Rub your thumb along the backside; you should feel a small burr all the way across the cutting edge. If there's no burr, then you're not sharpening up at the edge; so continue honing until you feel that burr.

Once you have that burr, remove it by rubbing the backside across your 8,000-grit stone. Go back to your 1,000-grit stone and refine the secondary bevel some more until all the scratches on your secondary bevel look consistent. Use less and less pressure as you progress on this stone and remove the wire edge on the backside as you go.

Put the 1,000-grit stone away

and get out a 4,000-grit waterstone, a hard black Arkansas oilstone or 600-grit sandpaper. Go through the same process you did with the 1,000-grit stone. Remove the wire edge on the backside with your 8,000-grit stone. At this stage, the bevel should look a bit polished in places.

Finally, you want to polish the secondary bevel with your finest-grit stone or 1,500-grit sandpaper. I use an 8,000-grit Norton waterstone. There are Japanese waterstones at this grit level, too. However there are no comparable oilstones. A translucent oilstone is somewhat close.

Polishing is a little different. You're not going to feel a wire edge on the backside of the tool. Work both the secondary bevel and the backside of the tool on the 8,000-grit stone and watch the scratches disappear. When they're gone, you're done.

Test the edge using your fingernail – see the photo for details. Some people finish up by strop-

## SHAPTON STONES: THE LATEST THING IN SHARPENING

If you think white-lab-coat wizardry is reserved for the manufacturers of power tools, think again. Some of the highest-tech science-fiction stuff happens in the knuckle-dragging hand tool industry: think unbreakable "nodular" cast iron, cryogenically treated tool steel and super-strong "rare earth" magnets that are incorporated into both tools and jigs.

And now the latest innovation is in sharpening. Shapton waterstones from Japan are all the rage among the sharpening gurus,

who say the stones cut faster and wear longer than other stones. They also can be expensive. There are several grades of the Shapton stones, and a basic setup of three stones can cost you anywhere from \$130 to \$220 – plus you'll need some way to flatten them.

We're using the stones in our shop now and will publish a full report in the coming months. If you want to check things out before that, visit [shaptonstones.com](http://shaptonstones.com) or call [JapaneseTools.com](http://JapaneseTools.com) at 877-692-3624 for more information.

## MORE HONING AND POLISHING



1 Continue honing the edge by switching to a 4,000-grit stone. Remove the burr on the backside with the 8,000-grit stone.

After working the 4,000-grit stone, here's what the secondary bevel should look like. It got a little bigger and it is more polished.

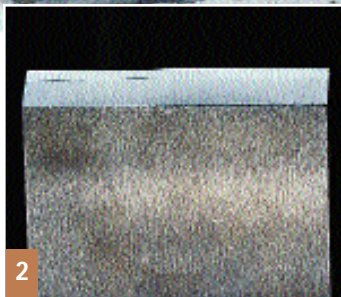

2



3

Repeat the same process on the 8,000-grit stone. You are almost finished. Tip: If your corners aren't getting polished, move the tool back  $\frac{1}{32}$ " in the jig.

Polish the secondary bevel on the 8,000-grit stone until it is a mirror.



4

ping their edges at this point with a piece of hard leather that has been charged with honing compound. I don't find it necessary. In fact, if you're not careful, you will round over your cutting edge while stropping.

Remove the tool from your

honing guide, wipe it down with a little oil to prevent rusting and go to work on some end grain.

The tool should slice through the wood with little effort. And if that doesn't convince you of the value of sharpening, I don't know what will. PW

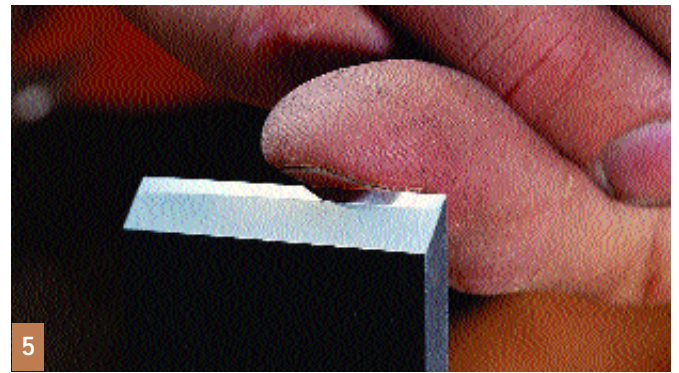

5

Here's how to test your edge without flaying your finger open. Pull your thumbnail across the edge at about a 90° angle. If the edge catches and digs in immediately, you're sharp. If it skids across your thumbnail, you have more work to do.

## TWO JIGS FOR ALMOST EVERY JOB

There are a lot of honing guides on the market these days. After trying out most of them, I'm convinced these two will handle almost all your edge tools.



The Veritas jig will help you hone tools that would normally have to be sharpened freehand. It's a good investment.

The gray side-clamp jig you see at every woodworking show and store is the workhorse in my sharpening kit. You can find this tool for about \$7 to \$13.

None of these gray jigs I've inspected grind a perfectly square edge, but they're real close. Be sure to tighten the jig's clamp with a screwdriver when you fix the tool in the honing guide.

The Veritas guide (Lee Valley Tools, 800-871-8158 or [leevalley.com](http://leevalley.com)) can handle many oddball tools. It easily clamps skew chisels, shoulder-plane blades, irons that are tapered in width and some not-so-stubby Japanese chisels. I don't use this jig as much for my run-of-the-mill plane blades and chisels with straight sides. It's much easier to clamp these in the gray side-clamp jig and go.

## SUPPLIES

Woodcraft  
800-225-1153, [woodcraft.com](http://woodcraft.com)

Side-clamp honing guide  
Item # 03A21, \$12.99

DuoSharp 8" coarse/x-coarse  
Item # 140966, \$79.99

Norton 1,000/4,000 waterstone  
Item # 818263, \$54.99

Norton 8,000 waterstone  
Item # 822462, \$89.99

Veritas honing jig  
Item # 03B41, \$24.99

Lie-Nielsen (800-327-2520 or [lie-nielsen.com](http://lie-nielsen.com)) sells the Norton stones. The 1,000/4,000 stone is \$45; the 8,000 stone is \$75.

Prices correct at time of publication