

THE

ATKINS SAW BOOK

for Home Craftsmen



TELLS
HOW TO

.... Start a
Home Shop

.... Select
the Correct
Saws & Tools

... CUT and
FIT the 24
Most-Used
WOOD
JOINTS

.... Build a
Work Bench,
Tool Box, etc.

Suggests
200 Things
to Make

Issued by the Makers of "SILVER STEEL" Saws

10c
a Copy

WE have available a limited supply of books entitled "YOU CAN MAKE IT" published by the United States Department of Commerce which shows plans for building different things about the house. If you are interested in receiving a copy of this book without cost, we will be very glad to send it to you prepaid.

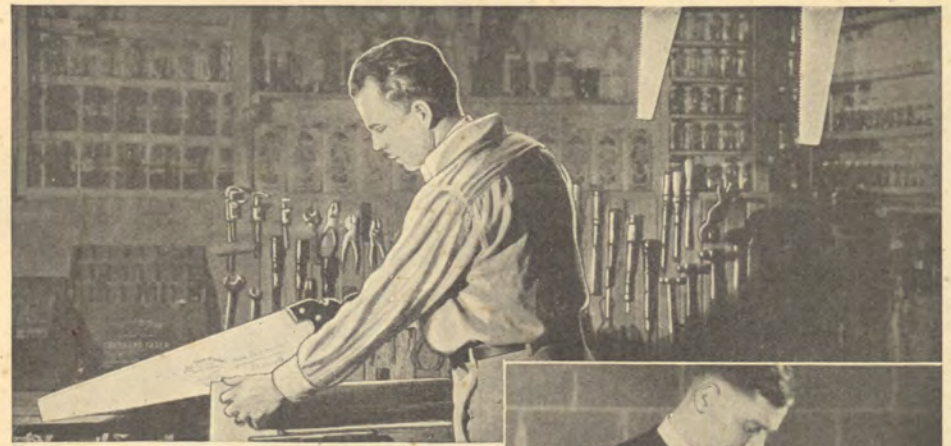
Remember, there is a limited supply, therefore, first come--first served while they last.

To All Who Like to Work With Fine Tools

May your perusal of this little book point the way to as many happy and profitable hours, in responding to the call of "The Home Workshop," as have been enjoyed by

The Author

First Edition 1— 9-30
Second Edition 1—10-30
Third Edition 2—12-30
Fourth Edition 2— 2-31



Whether you begin with just a few good tools and a bench in a corner of your basement, or have an elaborately equipped shop, you'll find home-crafting a fascinating hobby.

CHAPTER I

THE HOME WORKSHOP

Hobby and Educator!



EVERY man and boy should have a hobby—something that will give relaxation from the daily grind of office, shop or school. The ideal hobby is one which not only provides mental and physical play, but sharpens the senses and trains the hands. For, the late President Eliot of Harvard said these are just as essential to a well-rounded education, as cultivation of the mind.

No hobby meets all these requirements better than home-crafting—whether it means working with a simple tool kit and bench in a corner of the garage, or using an entire room in the basement, completely fitted up with an elaborate set of tools and machines. Large or small, a workshop will pay the home-crafter regular dividends in fun and satisfaction, as well as in steadier nerves and better health, to say nothing of the value and utility of the products constructed.

In America today, home-crafting admits no limitations of class or locality, age or sex. Workshops are found in all types of homes—from the prairie farm up to the suburban estate. And in the ranks of home-crafters are those from all stations of life—from the humble mechanic

to the wealthy business or professional man. Home-crafting appeals to all ages—fathers find the workshop a new center of genuine comradeship with their sons; girls and women enter into the spirit of this most fascinating pastime.

No longer is skill with tools considered a sign of mediocrity, as in past generations; in fact, many a lawyer has been more elated over the completion of a difficult task in his home shop than over his victory in a knotty legal case in court.

Many people who have taken up home-crafting just as a hobby, have found their new skill with tools a stepping-stone to a very successful business enterprise, that of making and selling articles of everyday utility. Others have developed their ability to build things into a sideline business which brings a most welcome addition to the family income.

Whether you are considering home-crafting as a source of pleasure or profit, lose no time in finding the best spot in your home for a shop, and begin to experience the thrills of genuine satisfaction which come to every one who has the creative and constructive instinct to "make things" with his own hands.



The home workshop is often a family affair, where father and son have good times together making things; mother and daughter are interested, too.

CHAPTER II

STARTING A HOME SHOP

MANY a man, admiring the attractive, useful articles one of his home-crafting acquaintances has produced, finds himself envying not only his friend's well-equipped home shop, but the enjoyment he derives from his hobby. Perhaps the reader of this booklet is at the point where he would start a workshop if space in his home could be arranged.

The following suggestions may point the way out of this difficulty.

The most popular place for the workshop seems to be in the basement, although many thousands of home-crafters find space in an attic or garage for their activities. Large space is not necessary; it is surprising what an efficient little shop can be arranged in a small area. Sometimes a spare room in the home may be used, even though "the lady of the house" may have visions of sawdust and shavings being tracked across her rugs.

Preferably the walls of the room selected for the shop should be of studding, concrete or masonry, which will not be damaged by the activities of the home worker. While it is highly desirable that the home shop be lighted by daylight, usually most shop work is done during

the evening with the aid of electricity, and lights should be placed as required.

Wall plugs or double sockets should be provided, if needed, for making connections to operate any motor-driven saws or machines you may install, if the shop is established in its permanent location.



Fig. 1—The quick, easy way to cut grooves is with an ATKINS Silver Steel Dado Head on your bench machine.

CHAPTER III

IMPORTANCE OF GOOD TOOLS

Especially Saws—the "Key Tools" of the Outfit

THE first problem which confronts the home craftsman who has selected the spot for his shop, is "What tools do I need?" So much depends upon getting the RIGHT quality and types of tools, that every beginner should first get the best possible advice on the subject. True craftsmanship is more than a matter of skill with the hands—it also means a thorough knowledge of the various types of tools and the correct ways to use them. It is better to begin with a carefully chosen assortment of the simplest tools, and acquire the knack and joy of using them correctly, than to invest a lot of money in an elaborate set which might be quickly depreciated by mis-use. As the worker gradually acquires more skill and undertakes more difficult tasks, he can add needed tools to his equipment at regular intervals without missing the investment.

Really GOOD tools are a delight to every true craftsman. Just to own them is a pleasure, and to put them to work is a most fascinating pastime. This ability to enjoy quality tools is inherent, but too often the desire to own the best is curbed by an inadequate budget. It is better to use economy in the number and types of tools purchased, than to skimp on quality. For, it is surprising what a wide variety of good work can be accomplished with a small group of well-selected tools, once the amateur has mastered the art of using them properly and keeping them sharp.

The prospective home worker may take a tip from the professional craftsman, who knows that his craft standing depends upon the quality and quantity of work he habitually produces, hence takes no chances with inefficient equipment. Each tool, his saws more specifically, must have the "feel" or the "balance" which permits him to be unconscious of it, for the tools of the skilled workman become virtually part of his anatomy. He knows that poor tools cannot be depended upon to behave themselves at all times and that their cutting edges do not stay sharp as long as they should.

If a highly skilled craftsman demands the very finest tools, how can the modestly skilled amateur hope to succeed with tools which the professional considers practically worthless? While combinations of metal and wood sold at the "Five and Ten" resemble certain tools, a comparison with an ATKINS product will convince the most skeptical of the tre-

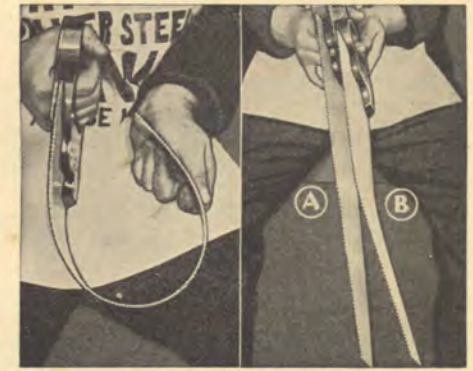


Fig. 2 (left) The bending test and Fig. 3 (right) its result to an ATKINS Silver Steel Saw (A) and an ordinary saw (B).

mendous difference in quality. If still in doubt regarding a saw, bend its point until it nearly touches the handle and release it; then if sighting along the tooth edge, we find the saw did not spring back to a perfectly straight edge, its low quality is evident. In no type of tool is comparative quality more apparent than in saws, which explains why the ATKINS SILVER STEEL SAWS are the "key tools" of the outfit of the discriminating craftsman; for tool quality is infallibly reflected in the excellence and quantity of his output. See Figs. 2 and 3.

This insistent demand for quality explains why the ATKINS products have successfully met sharp competition in the searching ordeal of practical work. Only by unvarying excellence have the ATKINS SILVER STEEL SAWS attained a leading position among their worthiest competitors. The accumulated successes of seventy-five years have made the ATKINS SILVER STEEL SAWS the synonym for highest attainment. Everything which contributes to making the ATKINS tools the most efficient and the "handiest" is brought to its highest perfection. The high technical accuracy of grinding each saw insures that its cutting edge is of exactly uniform thickness and the blade so accurately tapered that the back edge is from one to five gauges thinner than the cutting edge. This accurate grinding, "Damaskeen Polish," "Mirror Polish," and the careful placement of the handle insure perfect balance, the unusual "sweet cutting" qualities of ATKINS SAWS, and offer the logical explanation for their phenomenal growth and popularity.

TYPES OF SAWS AND USES

HAND SAWS—Cross-cut, to cut across the grain of the wood. The teeth are like two parallel lines of sharp knife points to cut the wood fibers. See Fig. 4. **Rip Saw**, to cut with the grain of the wood. Teeth are shaped like chisel points and they virtually chisel out the wood. See Fig. 5.

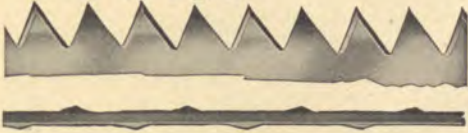


Fig. 4—Side and top views of CROSS CUT teeth of a hand saw.



Fig. 5—Side and top views of RIP Teeth of a hand saw.

MITRE SAWS—For use in the mitre box, to cut frames, moulding, etc. Stiff back and fine teeth. See page 23.

BACK SAWS—Similar to mitre saws, but smaller. Square at both ends. Used with or without mitre box, to cut fine joints or small stock. See page 23.

DOVETAIL SAWS—A small light back saw with extra small teeth for very fine work, as in dovetailing, pattern-making, etc. See page 23.

COMPASS SAWS—For sawing straight or curved cuts from a hole in the wood. Narrow, tapered blades of extra tough steel. See page 23.

KEYHOLE SAWS—Similar to compass saws, but blades are shorter and narrower. Extra strong and sharp. See page 23.

COPING SAWS—For cutting thin stock on curved lines, such as moulding joints, scroll work, brackets, wood toys, etc. Blade cuts at any desired angle, by simple adjustment. See page 23.

NEST OF SAWS—A combination of three saws—keyhole, compass and metal cutting blades—to fit in one handle. See page 23.

HACK SAWS—For cutting all kinds of metal. Rigid metal frame, adjustable to take blades of different lengths. Two types of blades—the old style alloy steel blades and the newer high speed steel blades. See page 26.

CIRCULAR SAWS—For cutting wood, are made in cross-cut or rip saw types; also, combination saws which cross-cut, rip or mitre equally well. The smaller sizes are widely used in workshops on motor-driven bench or portable sawing

outfits. See page 25. The larger sizes are used in mills and factories.

Circular Mitre Saws are especially made for smooth cutting, as in fine cabinet work, etc. See page 25.

DADO HEADS—For cutting grooves of any width from 1/4 to 4 inches. Set consists of two outside cutters and as many inside cutters as width of groove requires. Cuts with or across the grain, or diagonally, and leaves a very smooth, even groove. See page 25.

BAND SAWS—For use on power machines. Saws 2" or more wide, are used in lumber mills; the narrower saws are for use in woodworking factories and home shops. Blades are as narrow as 1/8"; lengths to fit various machines. See page 25.

MACHINE KNIVES—Small sizes are used on small home-workshop machines, such as planers, shapers, jointers, mortisers, moulders, etc. See page 26.

SCRAPER BLADES—For hand use in scraping floors, finishing surfaces, removing paint, etc. See page 24.

FILES—For sharpening saws and other cutting tools, for finishing wood or metal surfaces, etc. Many types—mill, flat, square, round, half-round, slim taper, hand saw, rasps, etc. See page 28.

SAW TOOLS—**Saw Clamps**, to hold saws when sharpening the teeth. **Saw sets**, to use in setting saw teeth accurately. **Hand Saw Filers** make filing a hand saw virtually automatic. See page 24.

Among the rip saws, panel saws, back saws, compass saws, keyhole saws, hack saws, dovetail saws, coping saws, meat saws, circular saws, band saws, groovers, etc., made by E. C. ATKINS AND COMPANY, the home worker or the professional may find just the saw for any required work upon wood, fibre, bone, or metal.



Fig. 6—An ATKINS Silver Steel Small Circular Saw speeds up cutting jobs in the home shop.

HOW TO SELECT YOUR TOOLS

THERE is grave danger that the enthusiastic prospective home worker with a well filled purse may make purchases of tools running into three figures. Another, obliged carefully to balance his desires and means, may buy a low-priced stock group of tools. The above methods show lack of the definite knowledge necessary to wise economy in purchasing tools. Once he has decided to start a shop, the worker may purchase tools as required, or plan to spend a certain amount each week or month until his outfit is sufficient for his tool needs.

To assist the new home worker we will suggest lists of tools which may be shortened or extended as desired.

Only approximate prices can be given as they fluctuate at different times, localities and even in neighboring stores.

The Handy-Man's Home Kit

With this group of tools, the home-worker will be equipped to undertake ordinary repairs and odd jobs around the home. While some of these tools may be used in building furniture, etc., others will be valuable only for repair work.

*1 ATKINS Hand Saw, 24", No. 9	\$1.50
*1 ATKINS Junior Mechanic Hand Saw, 20"	2.40
*1 ATKINS Hack Saw Frame and 8" Blade	
Number 10	2.50
*1 ATKINS Slim Taper File, 6"	.15
*1 ATKINS Mill Bastard File, 8"	.20
1 12-oz. Bell Face Claw Hammer	1.50
2 Screw Drivers, 3" and 6", Blade through Handle	.75
1 Wire Cutting Pliers, 6 1/2"	1.00
1 Zig-zag Rule, 4 ft. Aluminum, .85, or Wood	.40
1 Socket Firmer Chisel, 1/2"	.75
1 Block Plane, 7"	2.00
1 Combination Mitre Square, 12" Blade	1.25
1 Bit Brace Drill, 3/4"	.28
2 Auger Bits, 1/4" and 3/8"	.75
1 Ratchet Bit Brace, 8" Swing	2.50
1 Ripping Bar, 12"	.50
1 Cold Chisel, 1/2"x6"	.25
1 Putty Knife	.15
1 Glass Cutter, Multiple Wheel	.35
*1 ATKINS Wall Scraper, 3 1/2", No. 30	.45
1 Pipe Wrench, 10"	1.00
1 Auto Wrench, 9"	.50
1 Tinner's Snips, 3" Cut	1.75
1 Kitchen Grinder	\$1.00 to 3.00
1 Combination Oil Stone, 1"x2"x6"	1.25
1 Oil Can and Oil	.30
1 Iron Vise, 2" Jaws	2.25

The Home Craftsman's Outfit

The home craftsman who wishes his interest and skill to find expression in making furniture and accessories of beauty and utility for his home or camp, will find suitable tools in the following list.

*1 ATKINS Silver Steel Rip Saw, 22", No. 53	\$3.40
*1 ATKINS Silver Steel Panel Saw, 22", No. 53	3.40
*1 ATKINS Silver Steel Back Saw, 12", No. 2	2.70
*1 Nest of ATKINS Saws No. 3 (Nail Saw, Compass Saw, Keyhole Saw)	2.40
*1 ATKINS Hack Saw No. 10	2.50
*3 ATKINS Silver Steel Hack Saw Blades	.90
*1 ATKINS Coping Saw Frame, No. 50	.60
1 doz. extra blades	.25
1 Jack Plane, 14"	5.25

* E. C. Atkins and Company manufacture only the tools marked with asterisk. We do not make the others.

1 Bell Face Claw Hammer, 12-oz.	1.50
1 Block Plane, 7"	2.00
1 Chisel, 1/2" Socket Firmer	.80
1 Chisel, 1/2" Socket Firmer	.80
1 Chisel, 1/2" Socket Firmer	.80
1 Chisel, 3/8" Socket Firmer	.90
1 Screw Driver, 3" Blade Through Handle	.25
1 Screw Driver, 6" Blade Through Handle	.50
1 Bit Brace Drill, each No. 4, .18; No. 6, .23; No. 7, .25; No. 8, .28; No. 12, .39; No. 16, .53	1.86
1 Auger Bit, each 1/4", .50; 3/8", .50; 1/2", .55; 5/8", .75	2.30
1 Ratchet Bit Brace, 8" Swing	2.50
1 Shoemaker's Peg Awl Haft, with Extra Awls	.20
1 Combination Try-square, 12" Blade	1.25
1 Screw Driver Bit, 3/8"	.25
1 Rose Countersink, 1/2"	.50
2 Nail Sets, 1/4" and 1/8"	.25
*1 ATKINS Slim Taper File, 6"	.15
*1 ATKINS Mill Bastard File, 8"	.20
*1 ATKINS Cabinet Maker's Half Round Bastard File, 8"	.50
*1 ATKINS Spokeshave, No. 6	.45
1 Drawshave, 8" Blade	1.35
1 Mallet, 2 1/2" Face	.45
1 Combination Oil Stone, 1"x2"x6"	1.00
1 Oil Can and Oil	.30
1 Wire Cutting Pliers, 6 1/2"	1.00
1 Zigzag Rule, 4-ft.	.40
1 Fourfold Rule, 2-ft.	.50
1 Wing Divider, 6"	.60
1 Mortise Gauge, Double Bar	.50
*1 ATKINS Cabinet Scraper, 3"x5"	.35
1 Hatchet, 3 1/2" Edge	1.50

Supplementary List

Home craftsmen who undertake more ambitious work than their less experienced brothers of the craft may not find in the preceding list all the tools they need; hence the tools of the following list are suitable not only for their ordinary activities, but for most work of a professional range.

*1 ATKINS No. 400 Hand Saw, 26"	\$6.00
*1 ATKINS No. 400 Rip Saw, 26"	6.00
*1 ATKINS Dovetail Saw, 10", No. 25	1.60
*1 ATKINS Compass Saw, 14", No. 2	.90
1 Jointer Plane, 22"	6.95
1 Smoothing Plane, 9"	4.75
1 Rabbet Plane, 9"	4.75
1 Circular Smoothing Plane, 10"	8.00
1 Chisel, Socket Firmer 3/8"	.70
1 Chisel, Socket Firmer 5/8"	.85
1 Chisel, Socket Firmer 1"	.95
Tanged Firmer Chisels cost about 20% less.	
1 Screw Driver, 12" Blade Through Handle	1.00
1 Drill, each No. 2, .18; No. 3, .18; No. 5, .20; No. 9, .31; No. 10, .34; No. 11, .36	1.57
1 Auger Bit, each 5/8", .50; 7/8", .50; 1", .60; 1 1/8", .60; 1 1/4", .70; 1 1/2", .84; 1 3/4", .84; 1 7/8", .96; 1", .96	6.50
1 Bracebit, 8"	1.00
1 Expansion Bit, 5/8"-1 1/4"	2.50
1 Expansion Bit, 1/8"-3"	3.00
1 Depth Gauge for Auger Bits	.50
1 Automatic Drill, with Points	2.50
1 Breast Drill; may be used with round shank bits and drills, or fitted with a chuck to hold square shanks, for rapid boring	3.25
1 Hand Drill	2.75
1 Try-square, 6"	.50
1 Try-square, 12"	1.00
1 Steel Square, 16"x24", graduates in 12th.	2.00
1 Slip Joint Pliers, 8"	1.00
1 Round Nose Pliers, 6"	1.00
1 Wire Nippers, End Cutting, 6"	1.00
*1 ATKINS Half Round Pointed Tooth Rasp, 10"	.90
1 Grinder, 1"x6" Wheel	7.50
1 Set of Four Carver's Slip Stones	1.30

1 Slip Stone, Round Edge, 2"x4"x3/8" to 1/8".....	.50
1 Four Fold Rule, 2-ft.....	.50
1 Wing Dividers, 10".....	1.00
1 Pencil Clasp for Dividers.....	.15
1 Marking Gauge.....	.50
1 Cross Pein Riveting Hammer, 4-oz., handy in driving small brads.....	.85
1 Plumb and Level, 24".....	1.50
1 Brass Slide.....	1.50
1 Mortise Gauge, Useful in Grooving.....	2.75
1 Router Plane, Useful in Grooving.....	2.75
*1 ATKINS Perfection Scraper, No. 3.....	1.25
Carving Tools, range from 55c to \$2.50 each	
*1 ATKINS Bench Scraper, No. 1.....	.90
1 Socket Mortising Chisel, 1/4".....	1.25
1 Dowel Sharpener.....	.50
1 Dowel Plate.....	.65
1 Turning Saw, 14" with Extra Blades.....	1.50
*1 Ram's Horn Floor Scraper, No. 4.....	1.65
1 Scratch Awl.....	.15
Wood Mitre Box and Open Front Iron for Panel Saw.....	\$3.00 to 6.00
Iron Mitre Box.....	\$8.00 to 25.00
Saws not included. For a 24" box the saw should be not less than 28" long, 5" wide.	
*ATKINS Silver Steel Mitre Saw, as above.....	6.00
With this mitre box accurate cuts of prac- tically any angle may be made; length and depth gauges permit rapid work and accurate duplication of pieces.	
*1 ATKINS Saw Set, No. 395.....	1.50
*1 ATKINS Saw Jointer AAA, No. 15.....	.20
*1 ATKINS Hand Saw Filer, Fine results assured.....	2.70
1 Steel Vise, 2 1/2" Jaw.....	4.00
Wood Handscrews 8" jaws \$1.25 to	
12" jaws, each.....	2.00
Steel Screw Adjustable Hand Screws, 8", \$1.70; 12", each.....	2.55
Steel Bar Clamps, 2-ft., \$2.00; 4-ft.....	2.75
Glue Heater, Oil.....	\$3.00 to 4.00
Electric.....	\$6.00 to 25.00

Machines and Accessories—The more ambitious home craftsman will not rest content with even an elaborate equipment for hand work alone, after seeing the modern motor-driven bench machines, their simplicity, convenience and efficiency.

Hence we add a list of these tools and their equipment and suggest that in the advertising pages of popular scientific and mechanical magazines may be found the names of manufacturers who will gladly send any desired information regarding their products. We will, however, suggest certain features that should be considered in purchasing such machines and mention the ATKINS Saw equipment which guarantees the best possible results.

Bench Circular Saw Table—Sizes ranging from 12" to 14" wide and from 14" to 18" long. These tables use 4" to 8" saws, dado heads, buffing wheels, etc. Some of these are built for boring, jointing, sanding and other attachments. A table fitted with a removable throat to permit the use of a dado or grooving head is to be preferred. The table should have an adjustable squaring and mitring gauge, an adjustable ripping fence, and a safety appliance. The equipment for such a saw table should contain:

*1 ATKINS Silver Steel Circular Saw, 6".....	\$ 2.08
*1 ATKINS Silver Steel Mitre Saw, 6".....	3.40
*1 ATKINS Groover or Dado Head, 6"x1/2" to 1" by 16ths, No. 4 set.....	14.18
*1 ATKINS Silver Steel Grooving Saw, 1/4"x5", Patent tooth.....	5.33

*E. C. Atkins and Company manufacture only the tools marked with asterisk. We do not make the others.

Band Saw—Sizes of tables range between 13" to 18" wide to 13" to 20" long, the wheels allowing 11" to 18" swing; a

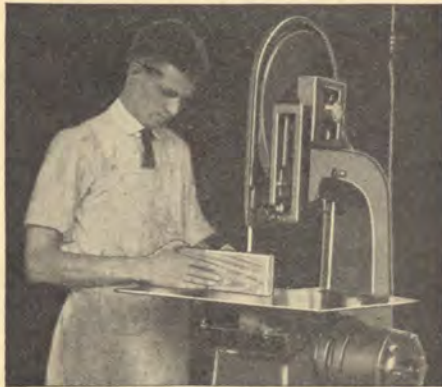


Fig. 8—Cutting curves is fast, easy work when your Band Saw has an ATKINS Silver Steel Blade.

tilting table is to be preferred. A good guide is necessary for best results.

*ATKINS Silver Steel Band Saws, 1/2", per ft.....	\$.091
*ATKINS Silver Steel Band Saws, 3/4", per ft.....	.091
*ATKINS Silver Steel Band Saws, 1", per ft.....	.126
*ATKINS Brazing Clamps.....	3.75
*ATKINS Brazing Torch, may be used for soldering.....	7.50
*ATKINS Brazing Tongs.....	4.00
Band Saw Guide, No. 0.....	10.00

Bench Jointer or Planer—These will take cuts from 4" to 6" wide and should be provided with adjustable fence and safety appliance.

*ATKINS Machine Knives for any Jointer, Planer or other machine, made to order. Prices sent on request.

Turning Lathe—A lathe with cone head stock or other method of changing speed is preferred. The lathe should take at least 28" between centers, 36" will be vastly more efficient.

Turning Tools, for cutting—chisels, 3/8", .60;	
5/8", .75; 1", 1.10; 1 1/4", 1.60	
Gauges, 1/4", .80; 1/2", .85; 3/4", 1.10; 1 1/4", .95	
Parting Tool, 1/2".....	.95
Scraping Tools about 20% less.....	
Carborundum Oil Stone, 1"x2"x6".....	1.00
Tapering Slip Stones, 2"x4"x3/8" to 1/8".....	.50
Outside Calipers, 8".....	.80

Jig Saw requires extra blades; automatic blowing attachment. ATKINS JIG SAWS (See page 26) are a great advantage.

An Electric Hand Drill—An assortment of drills, reamers, and countersinks fitted to the machine will be required.

Electric Bench Grinder—One 6" to 8" x 1" wheel. One 6" to 8" x 1/2" wheel, and 6" to 8" cloth buffers.

Emery Wheel Dresser.....	\$1.00
--------------------------	--------

*Atkins Bench Grinders for belt drive; with an assortment of various shaped ATKINS Grinding Wheels, practically any job of grinding can be done.

Bench Shaper; one spindle.

CHAPTER VI HOW TO MAKE WOOD JOINTS

HOW to make strong, accurate joints is something the new home worker must know before he can successfully build any article in his home shop. For, wherever two pieces of wood come in permanent contact, we have some type of joint. Regardless of its size or form, any thing we construct is made of separate pieces and the measure of the craftsman's skill is the accuracy of dimensions of each piece, and the strength and excellence of each joint.

The new worker should first acquaint himself with the different types of common joints, ranging from the simple butt joint up to the more complicated dovetail. In between these two types are the joints listed below:

- Lap Joints of several kinds
- Half Lap Joints
- Rabbeted Joints
- Grooved and Dado Joints
- Mitre Joints
- Mortise and Tenon Joints
- Dowel Joints
- Dovetail Joints
- Glued Joints
- Matched Joints
- Coped Joints

On the following pages all of the above types of joints are illustrated in detail and complete instructions given for mak-

ing them accurately. The worker will do well to study each type carefully, and should content himself with making practice joints with waste pieces until he feels confident of his ability to cut and work the stock correctly. Thus he will take no chances of making serious mistakes and destroying the pieces to be used.

With the Improved Perfection Handle used on many of the finest ATKINS Hand Saws, every ounce of power is exerted directly upon the cutting edge of the saw (see illustration 44). This type of handle

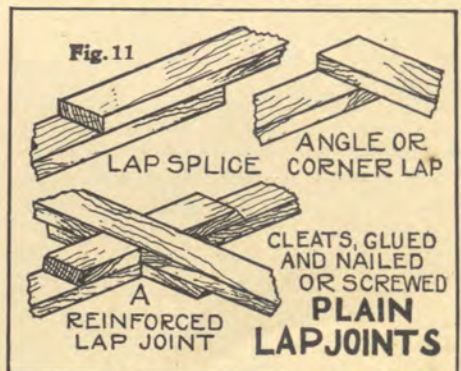
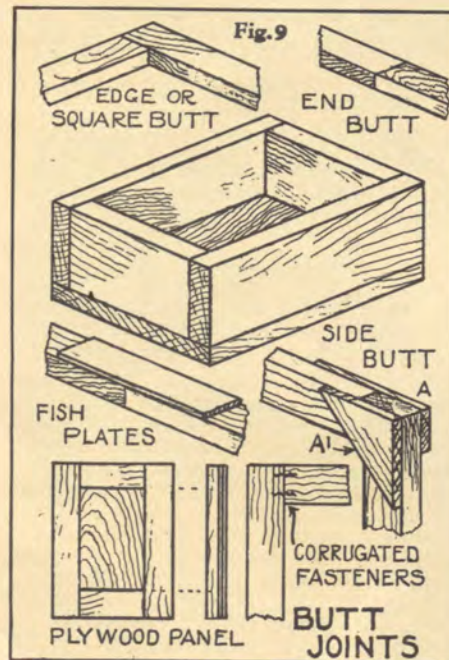
eliminates wrist strain, and makes the work easier. Note in Fig. 10, the proper position of the thumb, and the relation of the wrist, arm, elbow, shoulder and eye with line A, which is the direction in which the force of the stroke must be applied for straight sawing, as well as to keep the saw from catching and jumping.

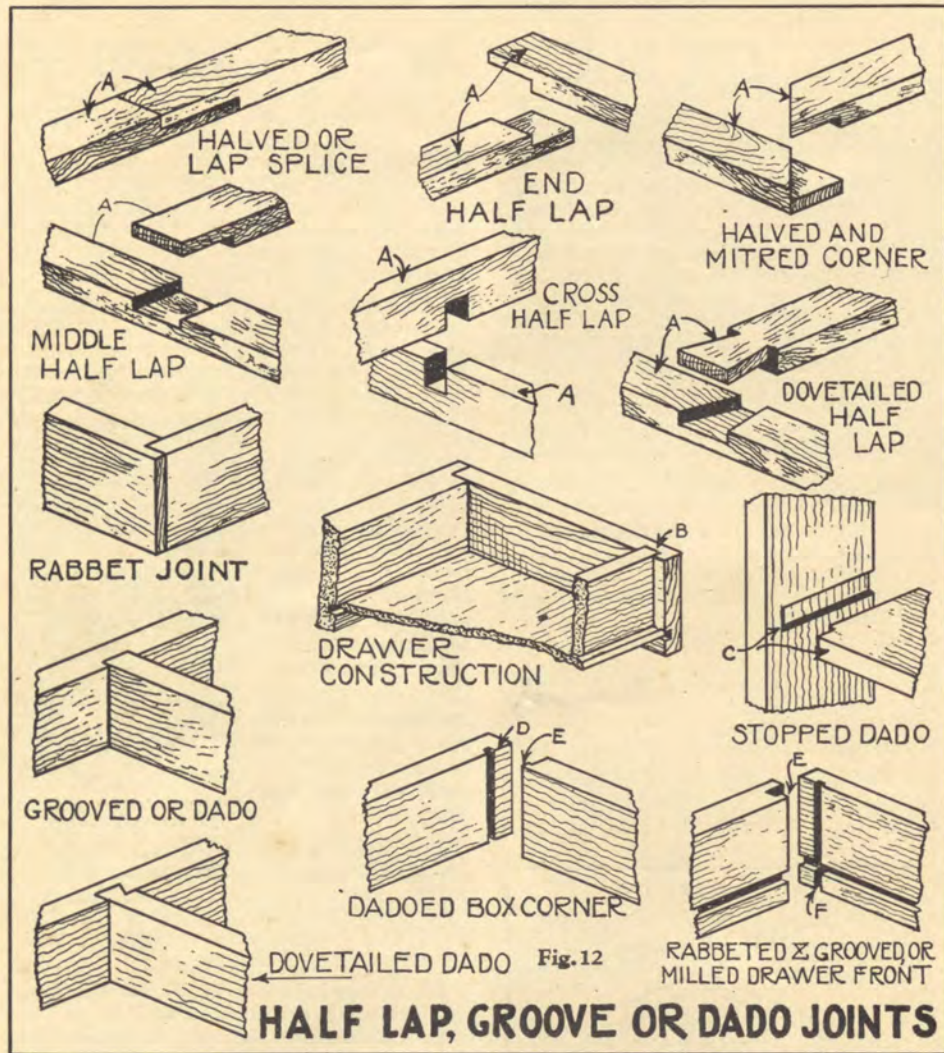


Fig. 10—Correct position for straight sawing.

Butt Joint—(Fig. 9)—This joint should be used only where the pieces may be fastened to other construction, reinforced by "fish plates," by a plywood panel as at A and A1, or with corrugated fasteners, or "dogs" as shown.

Plain Lap Joint—(Fig. 11)—This type of joint and the butt joint are of the simplest construction and constitute the fundamental methods of putting wood together. Often a lap joint may be reinforced by separate pieces as suggested in A which results in a lock joint.





Halved, Half-Lap Grooved and Dado Joints—(Fig. 12)—In laying out the cuts make all gauge marks and measurements from the face side A. Use the ATKINS SILVER STEEL BACK SAW No. 2, with 12" blade in cutting the shoulder (Fig. 13) and the same, or ATKINS SILVER STEEL RIP SAW in making the depth cuts (Fig. 14). In the lock joints, the depth cuts must be finished with a chisel.

The Halved, Spliced and Corner Joints (Fig. 12) are used in lengthening boards, and in screens and other frames that may be fastened with glue, clinch nails or screws. In laying out these joints, be sure and work from the face side A at all times. Often the rabbeted or shouldered joint is used in making drawers as suggested. Instead of the dado joint being

made at B, a butt joint may be used.

The Stopped Dado Joint is used where shelves or other members are fitted into grooves and would show as blemishes were they cut through (Fig. 15-c). The grooves should be laid out with a knife mark.

Place straight edge outside to coincide with knife mark on either side; hold it with brads as shown at D, or with hand-screws if preferred. The saw cuts must be made from the back edge and finished at the front with a chisel. A router plane will make the groove of uniform depth. In making a box with dadoed corners (Fig. 12), the piece D is the weakest place in the joint, hence the tongue E may be less than 1/8" thick. In making the milled drawer front, E should fit the groove F with a "push" fit.

The advanced homemaker with machine equipment can machine these joints. The dovetailed dado joint (Fig. 12), is very strong; often adaptations of it are found in 18th century chests of drawers.



Fig. 13—Cutting shoulders of half lap joint with ATKINS Silver Steel Back Saw No. 2, in bench hook.



Fig. 14—Making depth cut of half lap joint with ATKINS Silver Steel Hand Rip Saw No. 53.

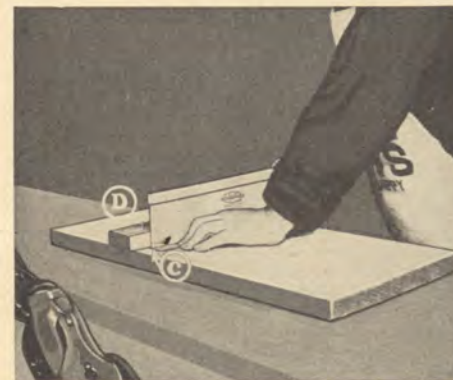
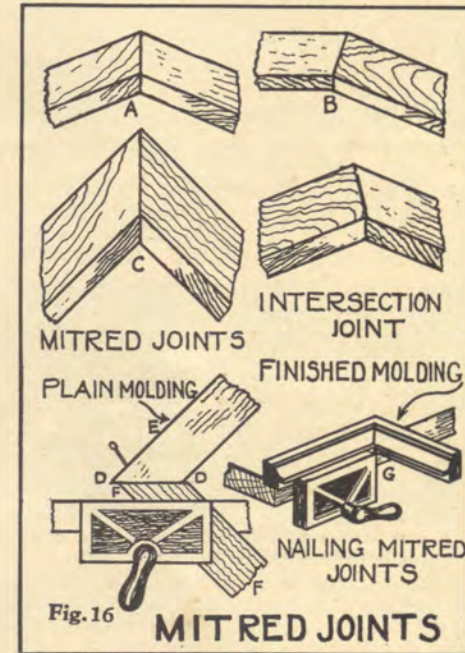


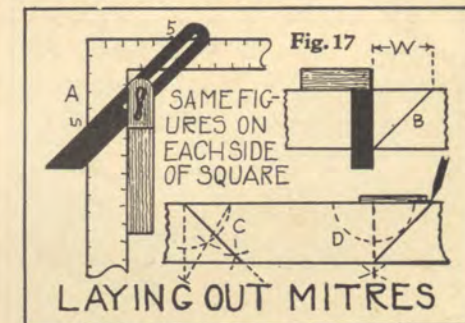
Fig. 15—Making cut in stopped dado joint, with ATKINS Silver Steel Back Saw.

Mitred Joints—(Fig. 16)—The mitre joint is commonly used in making picture frames and in the casings of door and windows. The intersection joint is made of

two pieces of different widths hence the angles are not equal. The usual mitre angle of 45 degrees may be laid out by setting a bevel to coincide with the same figures each side of a steel square as at A (Fig. 17) or by drawing square lines across the piece as at B, C, and D. An accurate mitre may be sawed with an ATKINS SILVER STEEL Panel Saw (Fig. 18) though usually they are cut in



a mitre box (Fig. 19). Note the angle at which the nail is entered in nailing a mitre at E (Fig. 16). Make a hole with an awl or small drill to insure that the nail is pointed right. Push the joint edge of E by the joint edge of F as at D to



allow the nail to draw E to its place as it is driven home. A finished moulding may be held in the vise as suggested at G of Fig. 16 without being marred.

Mitred joints may be fastened by glued dowels as in Fig. 20, with blocks rub



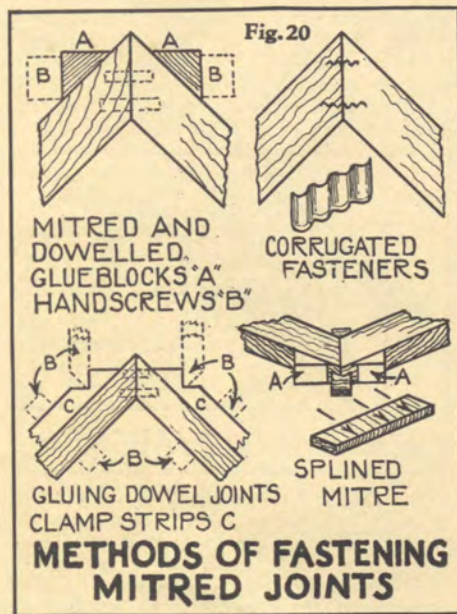
Fig. 18—Cutting a mitre joint with ATKINS Silver Steel Panel Saw No. 58.

glued as at A, clamp strips placed as at C (Fig. 21), or with corrugated fasteners. Or with a circular saw table and an ATKINS SILVER STEEL GROOVER,



Fig. 19—Using ATKINS Silver Steel Mitre Saw No. 1 to cut moulding in a mitre box.

each member may be grooved, and a spline or key, push fitted as suggested. Note that the grain of the spline runs the short way as indicated by the arrow



[10]

points. This joint may be glued, pushed together, the frame squared and the glue allowed to set. Blocks A and hand screws, or nails may be used if desired.

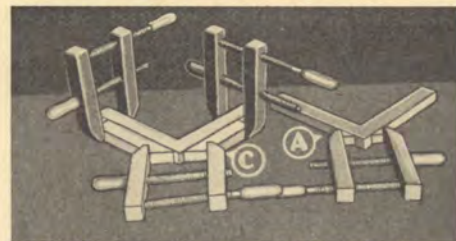


Fig. 21—Gluing mitre joint with blocks and clamps. Especially useful in making dowel mitre joints.

Mortise and Tenon Joints—(Fig. 23)—Joints of this type are used wherever the best constructive results are desired. Generally wedged forms of this joint are used only upon the best work. In making mortise joints follow the sequence indicated by the numerals of the sketch. In every case work from the face side G and in gauging. Locate the mortise accurately and square across the face and both edges as in step No. 1, marking with a pencil. Using a mortise gauge from the face side G, make the gauge lines of step No. 2 which give the width of the mortise. Do this on each edge for a through tenon, but on only one edge for a blind tenon (Fig. 22). Bore a hole about the width of

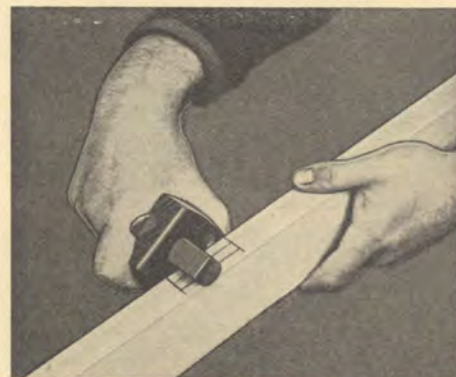


Fig. 22—Marking lines for a mortise and tenon joint with mortise gauge.

the mortise near the middle of its length as at 3 (Fig. 24). Beat out the mortise as in step 4 cutting from the hole each way, (Fig. 25), to about $\frac{1}{8}$ " from each end of the mortise as at J. Clean out the shavings and make the last cut as shown in step 6 exactly to the line thus making the mortise the correct length. In step 7 the tenon shoulder should be marked across the face with a knife point. Gauge mark both edges and end as in step 8, working from the face side G. In step 9 saw the shoulder closely beside the knife mark on each side down to the tenon gauge marks. Make cheek cuts by sawing exactly beside

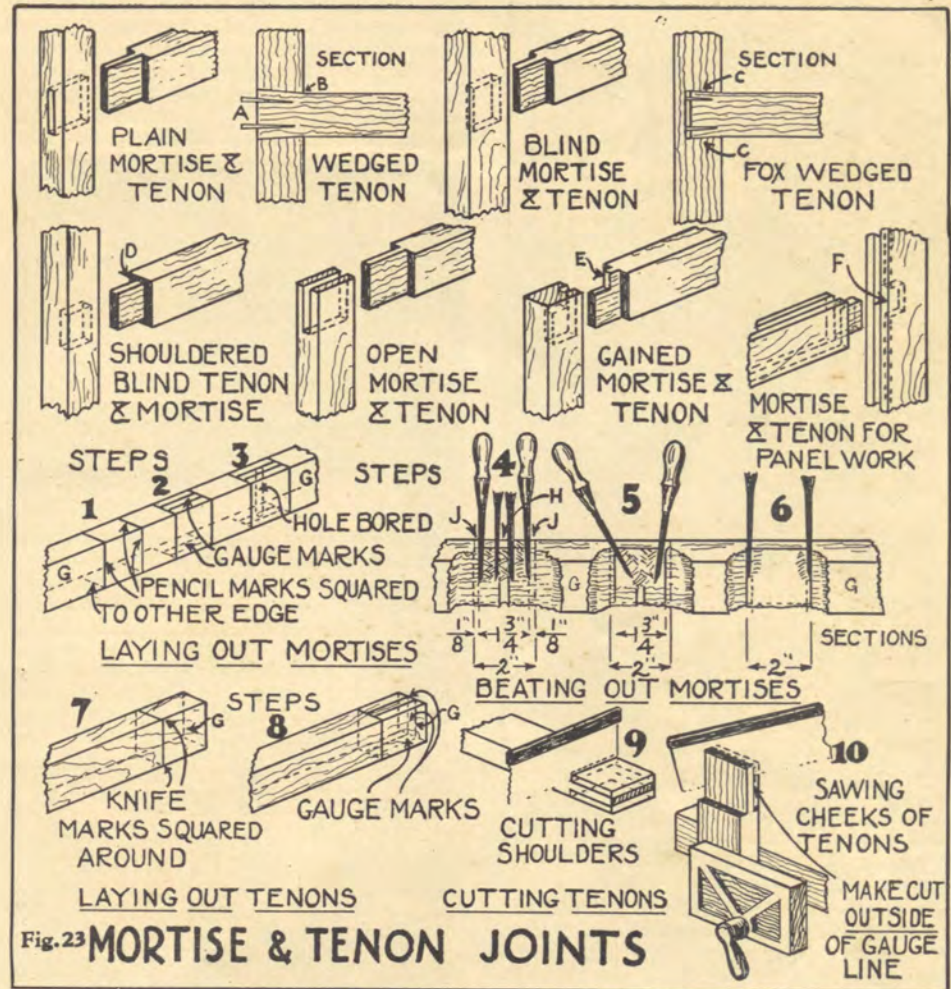


Fig. 23—MORTISE & TENON JOINTS

and outside of gauge lines as in step 10.

There are many varieties of mortise and tenon joints beside those shown in Fig. 23, such as the pinned or draw-pinned, the

keyed and the double mortise and tenon, but the home worker who masters the plain mortise and tenon will have little difficulty with the less common types.



Fig. 24—Boring holes to make a plain mortise.



Fig. 25—Beating out mortise. Spalls A sawed from cheeks of tenon B, as shown in Fig. 14.

[11]

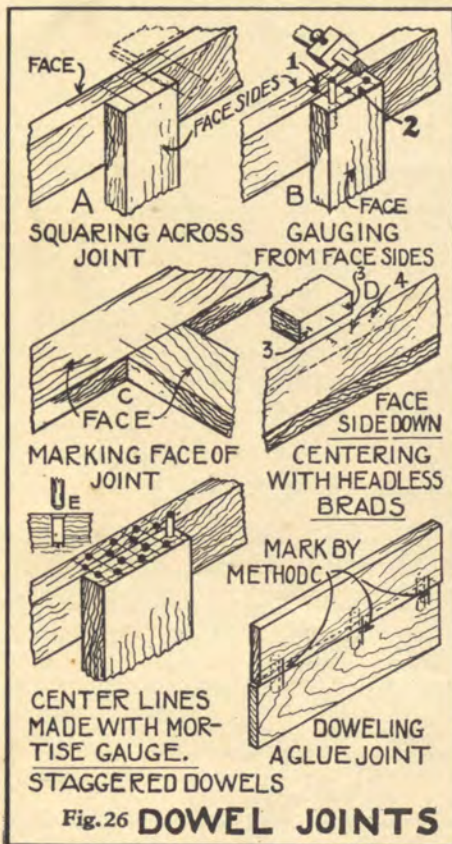


Fig. 26 DOWEL JOINTS

Dowel Joint—(Fig. 26)—The usual scamping of dowel joints upon cheap furniture has given this really excellent form of construction an undeserved reputation. A common method of laying out dowel centers is shown at A; place the pieces in correct relation and, using a try-square on the face side, draw lines across the two pieces as shown. With a single-point gauge held against the face make center lines cutting the three marks as at 1 and 2, which gives the center of the dowel.

In method C, lines are drawn across the face of a correctly placed joint, the pieces separated and the lines squared across the joint surface of each piece; the center lines made as at B locate the exact center of the hole. In method D, drive headless brads until they project about one-eighth of an inch as at 3. Lay both pieces face down, push the rail or the piece with the brads in its end against the other member at the exact place where the joint is to be made, thus marking the centers of the dowel holes 4 in the edge. Draw the brads from the end wood and the center hole will show plainly. Dowel centers in pieces of irregular forms may be located by this method. The staggered dowel joint is the strongest joint of the type and is used in

jointing a wide rail piece to a stile. Make two center lines with a mortise gauge, locate dowels and bore holes accurately. Sighting by the edge of a try-square, placed as in Fig. 27, will help in doing this. To insure uniform depth, the turns of the bit may be counted or a bit stop used. The



Fig. 27—Boring holes for a staggered dowel joint.

method of fitting and gluing a dowel mitre joint is illustrated in Figs. 20 and 21.

Generally $\frac{3}{8}$ " or $\frac{1}{2}$ " dowels are used, depending upon the thickness of the stock.

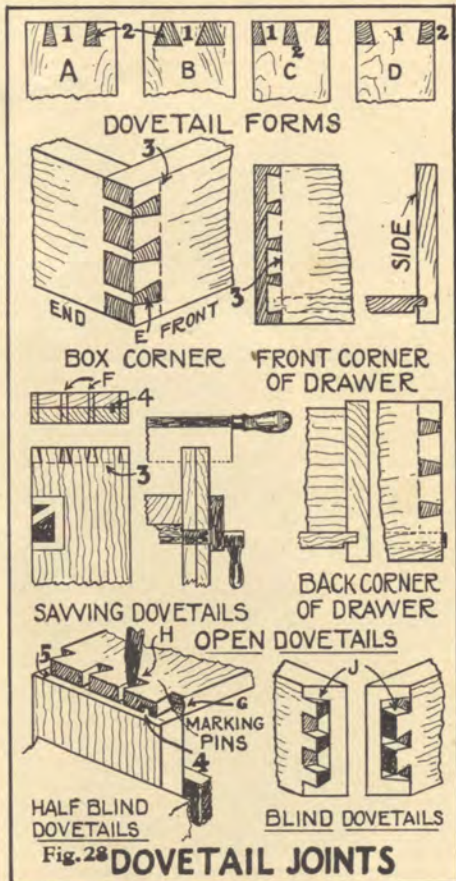


Fig. 28 DOWETAIL JOINTS

In every case, the dowels must enter the holes each side of the joint with a push fit.

Dovetail Joints—(Fig. 28)—To the bonafide home worker, the making of dovetails signifies the attainment of real skill. A shows the correct form of dovetail, for the sharp angles of the tail of B may be easily split off as suggested. As the strength of the dovetail joint depends upon the pins, joints D with but one tail is not nearly so strong as C.

In making a dovetail box allow the end wood of the pins E only to show on the front. Make a light gauge mark on each side of both ends of each piece as at 3. Lay out the tails by placing the sides in a vise and marking the tail lines across both ends as at F; the tails may be two or three times wider than the pins. Mark the tails with a bevel or a pattern, though generally the craftsman saws them by his eye. Cut outside the tail lines with an ATKINS SILVER STEEL DOVETAIL SAW; with a sharp chisel cut the piece out of the pin hole between the tails, cutting a little under from each side as at G. Place each end in the vise, lay side on end so edges and gauge marks exactly coincide; hold them rigidly, with brads if necessary, while marking closely beside the tail with knife point or scratch awl, as at H, though these marks extend entirely across the thickness of the end. This gives the pin lines. Number corners to permit replacing them. Make the saw cuts outside and closely beside these lines and beat out the spaces between the pins to receive the tails of the front, cutting a little under as above. Always cut exactly to the gauge lines.

In laying out half blind dovetails commonly used on drawer fronts, gauge the thickness of the sides on the inside and on the ends as at 5, working from the end

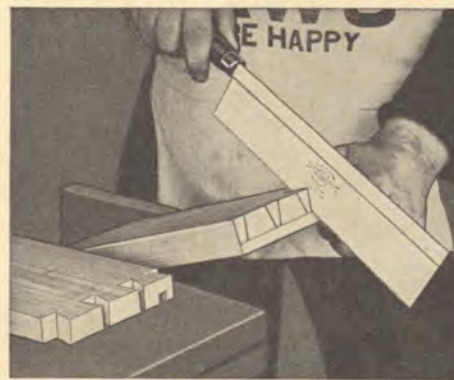


Fig. 29—Sawing half-blind dovetails with ATKINS Silver Steel Dovetail Saw.

and back side, or inside of the front. Lay side in its exact position on the front and mark as at H. Saw the triangular cuts for the half blind tails outside the pins, number corners and proceed as above. The mitres of a blind dovetail must be made

accurately. Allow the pieces J to project from each mitre for the tails and pins must be cut from these. Mark the tails and proceed as in making an ordinary dovetail. In gluing the box together, blocks may be glued on the outside and hand screws used as in Fig. 21.

Glue Joint—In making a glue joint, place one piece in the vise and joint one



Fig. 30—Making a glue joint. One piece in vise. Note how plane is carried straight, with fingers under it to guide, thumb on knob, and pressure on rear of plane at arrow.

edge with a well conditioned plane (Fig. 30). Note that the plane is carried straight, that it is cutting in the center of the iron, and that the fingers under the plane prevent its uncertain wobbling from side to side. The pressure should be upon the rear end, or the heel, as in-

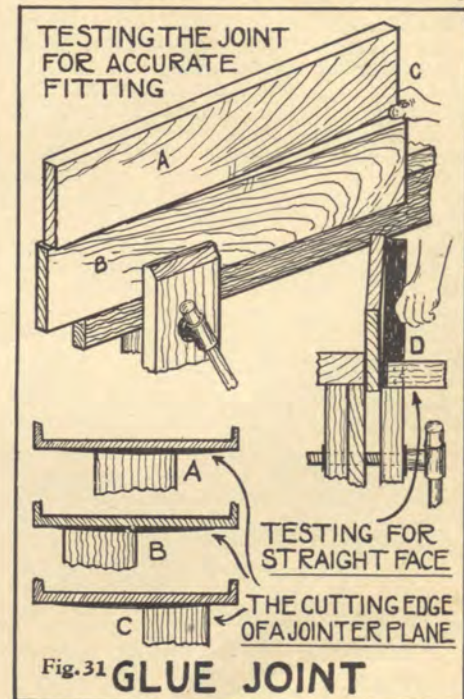


Fig. 31 GLUE JOINT

dictated by the arrow. Note the rather exaggerated shape of the cutting edge of the jointer iron (Fig. 31). A very fine shaving should be the rule while fitting. If the plane is cutting in the middle as at A, the shaving will be of equal thickness and the original squareness of the edge will be maintained. If the try-square shows the edge to be out of square, carry

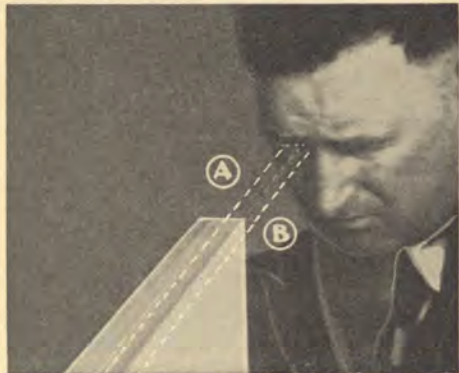
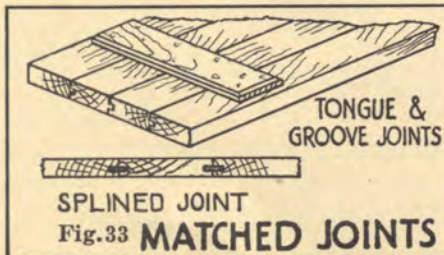


Fig. 32—To test joints before gluing, do not sight along center of edge A, but along corner, as at B.

the plane as shown at B or C as required. Generally in testing the joints, the novice sights along the middle of the width of an edge as at A. If his eye should instead follow the line B, he can see the corner of edge and detect any inaccuracy. (Fig. 32). To test the joint, place pieces as shown with the right hand as at C of Fig. 31; move A back and forth and it will swing upon any high place on either edge. With the jointer set to take a very fine shaving, plane the high places down until only the ends touch with a practically invisible joint between them. Reverse positions of the boards if necessary. Try the faces of the joint as at D, and remedy any defect by the method described at either B or C of Fig. 31. The glue joint may be reinforced by dowels as in Fig. 26. The homemaker who has an accurate power jointer may make the joint upon it.

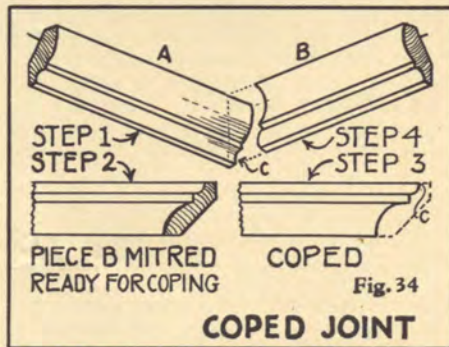
Gluing should be done in a heated room; to insure utmost speed and surety, set the work up dry, being sure that all clamps and appliances are set to desired size and placed conveniently at hand. If dowels are used, put glue in the holes of one side



on each joint, drive the dowels home, and try the work together to check possible errors before the glue is spread. After the glue has been applied and the clamps have drawn the pieces together, apply straight edges and hand screws if necessary to hold the surface of the work straight.

Matched Joint—(Fig. 33), Plain matching (tongue and groove) is commonly used in floorings, board partitions and doors. Matched flooring of oak, maple, birch, white wood or pine may be glued together for table tops.

Splined Joint—As a substitute for matched boards a splined joint gives good satisfaction. A homemaker with a bench circular saw table and an ATKINS groover, may easily groove the edges of a fitted glue joint and fit a spline the entire length, as suggested. (Fig. 33.)



Coped Joint—(Fig. 34)—In making this joint, moulding A of step 1 is first cut to length with square ends and nailed permanently in place. Moulding B in step 2 is then turned upside down in a mitre box and the mitre sawed as in Fig. 19. Cope this mitre as in step 3 using coping saw as in Fig. 35. When in place the joint will show as a mitre and driving nails will not force it open.



Fig. 35—Using the ATKINS Silver Steel Coping Saw No. 100 to cut moulding for a coped joint.

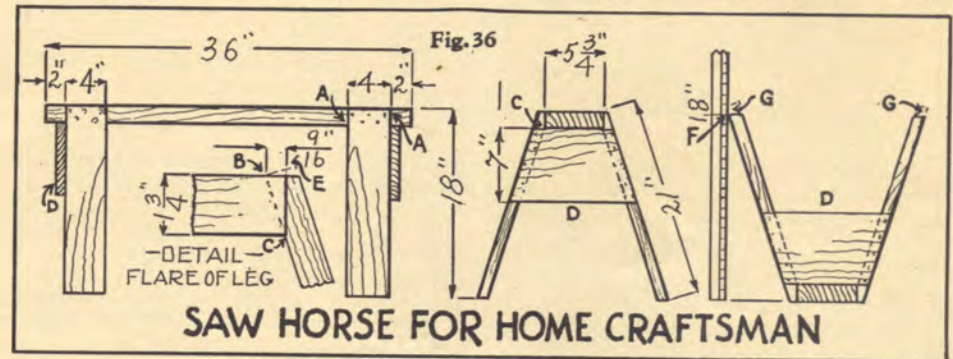
This type of joint is commonly used in fitting picture moulding around rooms, and whenever an inside mitre is made.

BUILDING YOUR SHOP OUTFIT

Saw Horses, Work Benches, Tool Box and Cabinet

NOW THAT the home craftsman understands how to make the various types of common joints he will encounter, he is ready to build the working outfit needed in his shop. For, we will assume that he starts with nothing more than the space for his shop, and the resolve to build his equipment himself. With no bench to work on, he should first build

a pair of saw horses. In making these, and other pieces of equipment for his shop, he will utilize many of the more common types of joints treated in the preceding pages. This will be valuable joint-making practice for him, and by the time his new shop outfit is finished, he will have confidence in his ability to make strong, tight joints of types most used in home shops.



Building Saw Horses

For building the saw horse shown in Fig. 36, pine, white wood, spruce, or any other easily worked woods may be used. The design shown in Fig. 36 is one which has been simplified as far as possible for construction by beginners. Many woodworkers prefer a saw horse on which the legs flare toward each end as well as outward, and give more stability. If this style of saw horse is desired, the minor change in leg design can be made as construction proceeds. To build the horse shown in Fig. 36, the following material is needed:

- 2 Tops—3'0" x 5 3/4" x 1 3/4".
- 8 Legs—21" x 4" x 7/8" (Full size).
- 4 Braces—13" x 1" x 7/8".

While as mentioned before, a large kit of tools may be bought for the first work, as but a few tools will be needed in making the horses, we will speak of these only.

- 1 ATKINS Silver Steel Cutting Off Saw, 22" or 24", No. 53.
- 1 Bell Face Claw Hammer, 12-oz.
- 1 Marking Gauge.
- 1 Chisel, 1".
- 1 Zigzag Rule, 4-ft.
- 1 Try-square, 6".
- 1 Pencil.

Usually failure to make an accurate cut with the above saw results from an incorrect posture in which the force was not applied in the same plane as the cut. (See Fig. 10.)

Step 1—Saw the two tops and eight legs to given length.

Step 2—With try-square mark pencil lines A (Fig. 36) to fit the legs and square across the top and each edge.

Step 3—Gauge line B between these lines 3/8" from the edge.

Step 4—Make a triangular saw cut between and beside lines A from B to C.

Step 5—With chisel cut the bottom of the groove from B to C.

Step 6—Nail legs in place, using 8d common nails.

Step 7—Place braces D, pencil mark the flare of each leg on the brace and saw to the marks.

Step 8—Nail braces with 8d common nails.

Step 9—Plane ends of braces flush with legs.

Step 10—Plane the top of the legs as at E flush with the top.

Step 11—Turn the saw horse upside down on the floor. With a rule, make a pencil mark 18" from the floor as at F, on each leg.

Step 12—Place a straightedge to these lines and draw a pencil line from one to the other across edges and sides of the legs.

Step 13—Saw carefully to these lines, cutting off pieces to G.

Step 14—Turn the horse right side up and it should rest firmly on the floor.

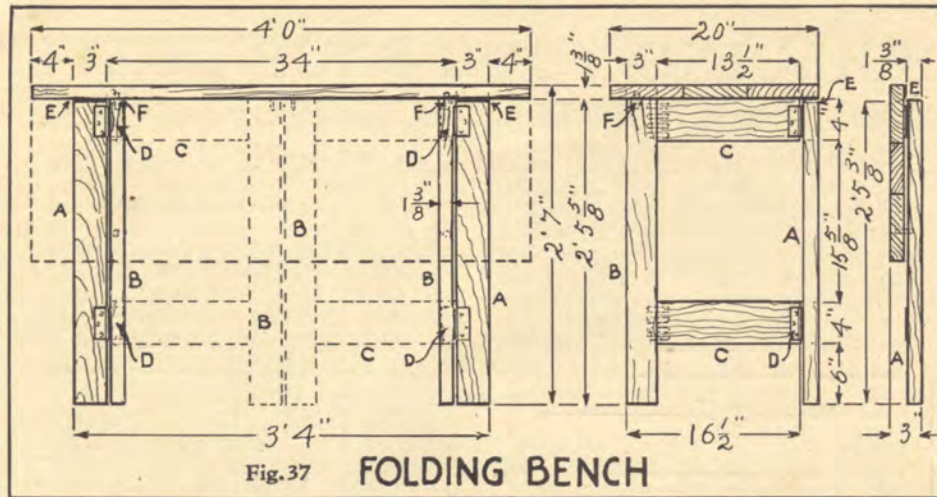


Fig. 37 FOLDING BENCH

Folding Work Bench—(Fig. 37)—To aid those dwelling in restricted quarters realize their desire to join the "Fraternity of Home Craftsmen" we would suggest this folding bench, the top of which may be folded down and project not more than 3½" from the wall.

The bench may be built of any moderately hard wood; white wood we will say. Beside the tools needed to build the saw horses, we shall need:

- 1 Bit Brace, 8" Swing.
- 1 Auger Bit, ¼".
- 1 Drill each ⅛" and ⅜".
- 1 Screw Driver, 6" blade.

The following stock list may be worked out at the mill or at home.

- 1 Top 4'0"x20"x1¾". May be dowel glued in two or three pieces.
- 2 Back Legs A 2'5½"x3"x1¾".
- 4—Rails C 13½"x4"x1¾".
- 6 Steel Butts, 3"x3" with 1¼" screws.

With these at hand we will proceed as follows:

- Step 1—Glue up top.
- Step 2—Trim top to exact size.
- Step 3—Fasten the back legs to the wall with screws or bolts.
- Step 4—Join front legs B and rails C with ½" dowels.

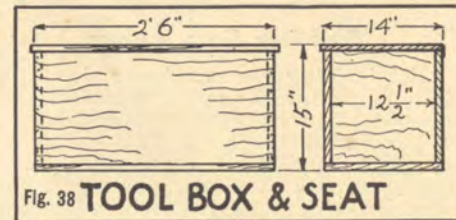
Step 5—Place the leg frames between the back legs as shown by dotted lines of the front view. Fasten 3" hinges at D with 1¼" screws with the top rail ¼" or the thickness of the closed hinge above the top of the back leg at E.

Step 6—Fasten hinges permanently to the under side of the top and to the top of the back leg A with one screw in each hinge.

Step 7—Raise the top, open legs at right angles with the wall, drive a headless brad in the top of each front leg at F; drop the top carefully upon the brads

which will mark the centers of the dowel holes in the top.

Step 8—Draw brads, close the legs, and remove screw in hinges, bore ½" holes for dowels in the top at F and in the top of the front legs. Glue the dowels in the holes in the top, replace the top and fasten permanently to the back legs.



Tool Box and Seat—(Fig. 38)—This easily made piece of shop equipment serves as a handy seat and as a convenient repository for tools. It may be made of pine bass wood or white wood. It will need:

- 1 Top 2'7"x14½"x¾".
- 2 Sides 2'6"x13½"x¾".
- 2 Ends 12½"x13½"x¾".
- 1 Bottom 2'6"x14"x¾".

When squared at the mill or cut by hand, the pieces are ready to be nailed together with 8d finish nails. The cover may be hung with 2½" narrow brass butts and the chest stained or covered with cloth of desired color and texture. The tools used in making the saw horses and bench will be ample for making this chest.

Home Worker's Handy Bench—(Fig. 39). This bench may be made of any easily worked wood, and when completed the home worker may undertake almost any kind of work, for the masterpieces of the old cabinet makers were produced upon benches of the same type. The iron plate at A adds much to the efficiency of

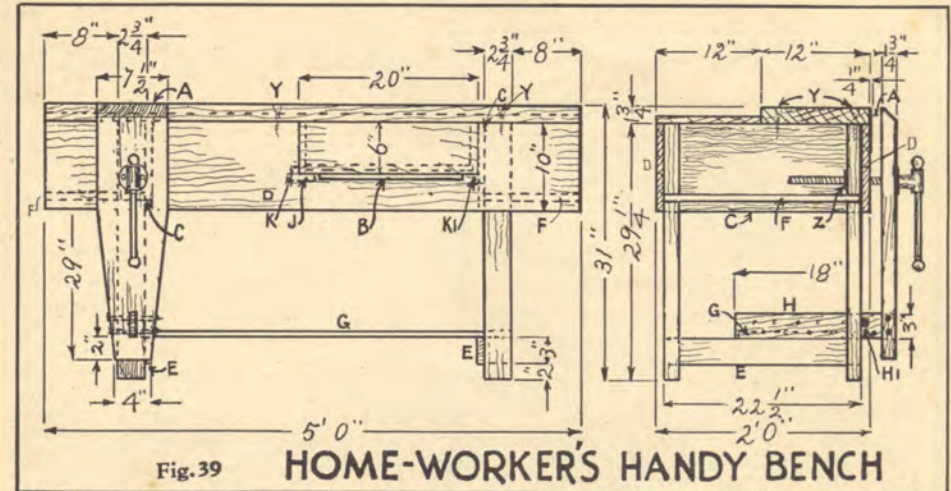


Fig. 39 HOME-WORKER'S HANDY BENCH

the vise, and the 1" hand hole B under the drawer is a great convenience for odd jobs of sawing. An iron tail vise may be fitted if desired.

The following pieces may be cut to exact size at the mill if preferred, but the home worker will lose a lot of fun with his ATKINS Silver Steel Saws.

- 1 Front Top, 5'0"x12"x1¾". Preferably hardwood.
- 1 Back Top, 5'0"x12"x¾". The two pieces should aggregate 24" in width.
- 2 Ledges C, 22½"x10"x¾".
- 2 Front and Back Aprons D, 5'0"x10"x¾".
- 2 Ledges E, 22½"x3"x¾".
- 4 Legs, 2'5½"x3"x1¾".
- 2 Supply Shelves F, 22½"x10"x¾".
- 1 Supply Shelf G, 2'5"x12"x¾".
- 1 Drawer Front, 20"x6"x¾" (Rabbeted as in Fig. 12) to receive ¾" sides.
- 2 Drawer Sides, 22½"x5½"x¾".
- 1 Drawer Back, 18½"x5½"x¾".
- 1 Drawer Bottom, 20"x16"x1½".
- 1 Vise Jaw, 2'5½"x7½"x1¾"—Oak or Maple.
- 1 Traveller H, 18"x3"x¾".
- 1 Drawer Run J, 22½"x4"x¾".
- 2 Drawer Runs K and K-1, 22½"x1"x¾".
- 1 Vise Plate A, 7½"x5"x1¼"—Iron or steel with countersunk screws.
- 1 Vise Screw 1" diameter.
- 18 No. 12 Flat Head Screws 2¾".
- 3 lbs. 8d common nails.

Beside the tools mentioned in the two previous projects we shall need:

- ATKINS Half Round Wood File, 8".
- ½" chisel for fitting vise screws.
- ¼" drill bit for boring for screws that fasten the bench top.
- 1 ATKINS Compass Saw.

In assembling square all angles. Step 1—Bore 1½" holes in the front leg to receive the vise screw, 6¼" from the top of the leg to the center. If an extension bit is not available, bore several half-inch holes and finish with a chisel and an ATKINS Half Round Wood File. Fit the nut Z and fasten with screws.

Step 2—Cut a mortise 5" from the bottom of the leg which will allow the traveller H to slide freely but not loosely. Bore holes as shown to receive ¾" foot bolts H-1.

Step 3—Nail ledges C and E in place with 8d common nails.

Step 4—Place aprons D and fasten with nails. Step 5—Continue holes for the vise screw through the aprons.

Step 6—Cut openings in the front apron for the drawer front and the hand holes. Verify measurement by the drawer front. (Fig. 40).

Step 7—Nail drawer runs J and K-1 in place.

Step 8—Assemble drawer; fit and nail the back between the sides 15¼" from the back of the front with a butt joint. Nail the bottom to the bottom edge of the drawer sides. Fit the drawer and nail run K in place beside it.

Step 9—Nail supply shelves F in place. Step 10—Plane tops of legs, ledges and aprons flush.

Step 11—Bore ½" holes, ½" deep and finish with ¼" drill as at Y. Fasten the front top strongly with 2½" No. 12 screws, especially at the vise. Glue wooden plugs in holes and plane flush with bench top.



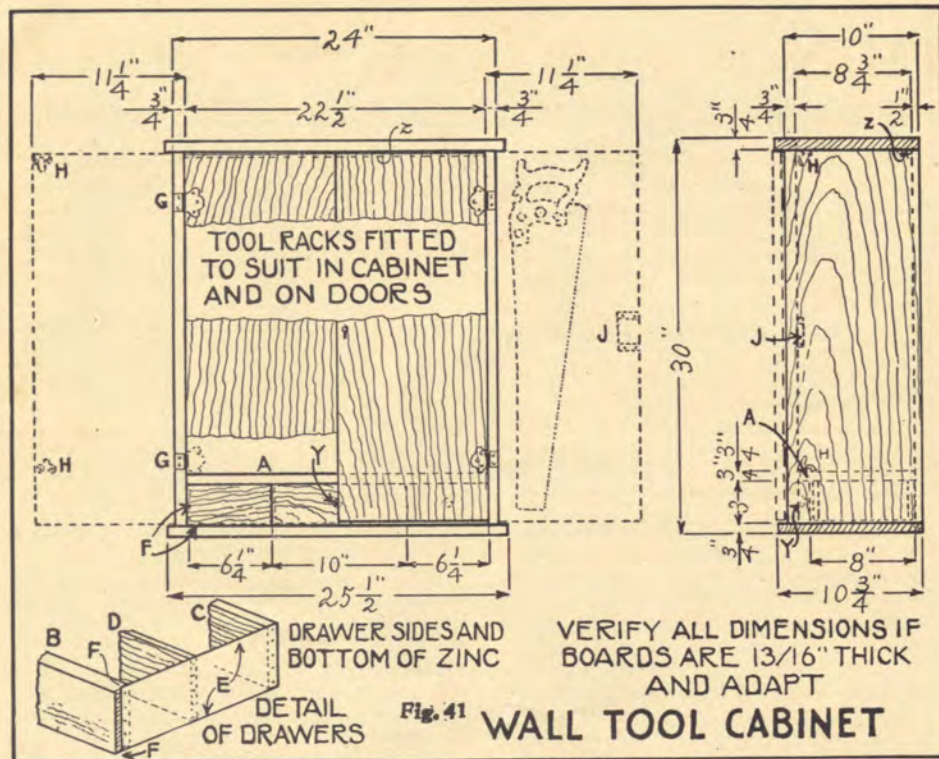
Fig. 40—Cutting drawer opening and hand hole in bench apron with ATKINS Silver Steel Rip Saw; showing ¾" holes bored at A, and the use of ATKINS Compass Saw in starting the cut.

Step 12—Cut mortise in the vise jaw to receive traveller H and hold in place with ¾" bolts as shown. Place the traveller in the leg mortise to support the vise jaw a little above the top of the bench.

Step 13—Locate accurately and bore a rather close fitting hole in the jaw to receive the vise screw.

Step 14—Fit the vise screw and fasten to jaw; put vise in place and set it up. Cut the top of the vise jaw off so it will rest flush with the top of the bench, and bevel as shown.

Step 15—Nail supply shelf G in place.



Wall Tool Cabinet—(Fig. 41)—The wall cabinet may be built of pine, white wood or cypress, which may be stained and varnished and be quite as efficient as a more elaborate cabinet. Among the tools used in making the saw horses and bench will be found all that are necessary to build this cabinet. The following list of material will be needed; $\frac{3}{4}$ " boards are mentioned, but if boards are $\frac{1}{2}$ ", allowance must be made in cutting to sizes.

- 2 Top and Bottom, $25\frac{1}{2} \times 10\frac{3}{4} \times \frac{3}{4}$ "
- 2 Sides, $28\frac{1}{2} \times 10 \times \frac{3}{4}$ "
- 1 Back, $28\frac{1}{2} \times 22\frac{1}{2} \times \frac{1}{2}$ " board or ply wood.
- 1 Furring Z, $22\frac{1}{2} \times 1 \times \frac{1}{2}$ "
- 1 Shelf A, $22\frac{1}{2} \times 8\frac{3}{4} \times \frac{3}{4}$ "
- 2 Doors, $28\frac{1}{2} \times 11\frac{1}{4} \times \frac{3}{4}$ "
- 1 Drawer Front B, $10 \times 8 \times \frac{3}{4}$ "
- 1 Drawer Back C, $9\frac{1}{8} \times 27\frac{1}{8} \times \frac{1}{4}$ "
- 1 Drawer Partition D, $9\frac{1}{8} \times 27\frac{1}{8} \times \frac{1}{4}$ "
- 2 Drawer Fronts, $6\frac{1}{4} \times 3 \times \frac{3}{4}$ "
- 2 Drawer Backs, $6\frac{1}{8} \times 27\frac{1}{8} \times \frac{1}{4}$ "
- 2 Drawer Partitions, $6\frac{1}{8} \times 27\frac{1}{8} \times \frac{1}{4}$ "
- 1 Drawer Bottom and Sides E, $15\frac{1}{4} \times 7\frac{3}{4}$ "
- 2 Drawer Bottoms and Sides E, $12 \times 7\frac{3}{4}$ "
- 2 Pairs of Surface Butts G.
- 2 Spring Door Catches H.
- 1 Cupboard Lock J.

To assemble:
Step 1—Fasten top and bottom and sides with 6d finish nails or 2" No. 10 round head screws. Be sure the distance between the sides equals the length of shelf A. If made of hardwood the surface should be scraped with ATKINS Scraper before sand papering and assembling. (Fig. 42.)

Step 2—Fasten shelf A with nails or screws; be sure it is placed just the width of the drawer fronts from the bottom.

Step 3—Nail furring Z in place and fit and nail the back to Z and to shelf A.

Step 4—Fit and hang the doors with surface butts as suggested. The door may be glued of narrow pieces to resist warping, if quarter sawed boards are not available, or they may be cleated on the inside. Panelled doors may be made if desired.

Step 5—Bend the sheet metal drawer bottom and sides accurately. Fasten with 1" No. 16 wire nails and fit the drawer fronts.

Step 6—Place tools in the cabinet as desired; fit blocks, racks or screws to support them.

Step 7—Stain, shellac, varnish or paint the cabinet inside and out as preferred.

Step 8—Fit spring door catches H to the inside of the door as shown and place a small knob Y in the center of each drawer front.

Step 9—Hang the cabinet on the wall by driving screws through the back into the wall studs, or put up cleats to support cabinet. On masonry walls, drill holes and drive in wood plugs for screws.



Fig. 42—Using an ATKINS Silver Steel Scraper Blade on hard wood, in building wall tool cabinet.

THINGS FOR YOU TO BUILD

200 Suggestions and Where to Get Plans and Data

THIS booklet deals primarily with starting the home shop and equipping the worker with the basic knowledge he needs to build things successfully in his new shop. From this point he can follow which ever branches of home craftsmanship are best suited to his natural ability. So, instead of describing a great variety of projects similar to the hundreds already published, we shall list a number of project suggestions, and tell where each home worker can find just the plans and data he desires.

Key to Numbers Used in Lists Below

The figures which follow each article listed below designate the publishers who will furnish job plans or working descriptions to aid the reader in building this particular project. For example: "Arm Chair, 1" means that Popular Science Monthly can furnish job plans for this project. All requests for information and price of these plans or construction details must be sent direct to the publishers, and NOT to E. C. ATKINS AND COMPANY.

Key	Publisher of Plans	Address
1	Popular Science Monthly	381 Fourth Avenue, New York City.
2	Popular Mechanics Magazine	200 East Ontario Street, Chicago, Illinois.
3	Popular Homcraft	737 N. Michigan Avenue, Chicago, Illinois.
4	LePage's Craft League	725 Essex Street, Gloucester, Massachusetts.
5	Wood Utilization Commission	U. S. Department of Commerce, Washington, D. C.
6	National Lumber Manufacturers Association	702 Transportation Building, Washington, D. C.
7	Science and Invention	381 Fourth Avenue, New York City.
8	Modern Mechanics	Dept. D. 5. Minneapolis, Minnesota.

- Airplane, 8
- Airplane, Model, 1, 2, 3, 7, 8
- Airplane Propellers, 1, 3, 8
- Alcove, Dining, 1, 2, 6
- Antique Mirror, 1
- Aquaplane, 2, 5, 7, 8
- Aquarium, Built-in, 2
- Arbor and Gate, 1, 2, 8
- Archery Set, 1, 8
- Arm Chair, 1
- Ash Tray, Egyptian, 2
- Ash Tray, Stand, 2, 3, 8
- Baby Crib, 1
- Bedroom Chair, 7
- Bedstead, Wooden, 7
- Bench for Shop, 1, 2, 3, 4, 5, 7, 8
- Bench, Black-Cat, 2
- Bench Model Plane, 2
- Bench, Spanish, 2
- Bird Houses, 1, 2, 3, 4, 5, 8
- Block Puzzles, 1, 2
- Boat for Pool, 2
- Boat Models, 1, 2, 5, 8
- Boat, Motor, 2, 8
- Boat, Simple, 7
- Bob-Sled, Water, 7
- Bookcases, 1, 2, 3, 4, 5, 7
- Bookcases, Skyscraper, 2, 7
- Book Ends, 1, 2, 3
- Book Shelves, 1, 3, 4
- Book Stands, 1, 3, 4
- Book Trough, 1, 2, 3, 4
- Boomerangs, 2
- Bootery Box, 6
- Boudoir Lamp, 7
- Box Kite, 5, 8
- Box Raft, 5
- Bracket Shelf, 2
- Breakfast Cabinet, 2, 6
- Brooder Coop, 5, 8
- Broom Cabinet, 1, 2, 3
- Built-in Cabinets, 2, 6
- Cabinet, Sewing, 1, 2, 3, 4, 7
- Cabinet, Spanish, 2
- Cabinet, Stove, 2
- Camp Car, 2
- Camp Furniture, 1, 5
- Camp Refrigerator, 5
- Car Jack, 5
- Card Table, 3
- Canoe Mast-Sails, 2
- Cedar Chest, 1, 2, 3
- Chess Table, 2, 4
- Chest, Colonial, 1
- Chest, Drawers, 1, 3, 4
- Chest, Pirate, 2
- Chest, Tobacco, 2
- Chest, Treasure, 1, 3
- Chest and Seat, 4
- Chicken Run, 2
- Child's Slide, 3, 8
- China Closet, 2, 4
- Cigarette Chest, 2
- Clock Cases, 1, 2, 3, 5
- Clothes Drier, 5
- Coach, Models, 1, 3
- Coaster, Snow, 1, 2, 5
- Coaster Wagon, 3
- Coffee Table, 2, 3
- Colonial Closet, 1
- Colonial Desk, 1
- Colonial Mirror, 1, 4
- Covered Wagon, Model, 1
- Cruiser, 16-inch Outboard, 2
- Cupboards, China, 1, 2, 3
- Cross-Bows, 2
- Cyclé Car, 2
- Desk and Bench, 6
- Desk Chair, 5
- Dining Alcove, 1, 2, 6
- Dog House, 3, 5, 7
- Dog Sled, 5
- Doll House, 1, 3
- Doll House Furniture, 1
- Doors Screen, 3
- Doors, Storm, 3
- Dresser, Kitchen, 1, 6
- Dynamic-Speaker Stand, 2
- End Tables, 1, 3, 4, 7
- Egyptian Ashtray Stand, 2
- Electric Exerciser, 2
- Fence Trellis, 1, 2, 3
- Fern Stand, 4
- Flat Top Desk, 1
- Flower Boxes, 3, 4
- Folding Screens, 1, 2, 3, 4
- Fireless Cooker, 5
- Fire Screen, 4
- Foot Stools, 2, 3, 4, 5, 7
- Foot Scraper, 5
- Game Tables, 1, 2, 3, 4, 5
- Garage, 1 Car, 1, 2
- Garden Bench, 2
- Garden Chair, 7
- Garden Gate, 1, 2
- Garden Seat, 1, 2, 3, 7
- Garden Swing, 3, 7
- Garden Table, 3
- Garden Trellis, 1, 2, 3, 4, 5
- Glider, Simple, 7, 8
- Grandfather Clock, 1, 2, 8
- Gymnasium Equipment, 2
- Hanging Shelves, 1, 2, 4
- Heated Dog House, 7
- House, Play, 3, 4
- House, Dolls, 1, 3
- Horizontal Bar, 2
- Horse, Gymnasium, 2
- Hydro-plane, Racing, 2
- Ice Boat, 2, 8
- Ice Box, 2
- Ice Skater, Push, 7
- Inlaid Tray, 3
- Ironing Board, 2
- Japanese Summer House, 2
- Jewel Case, 3
- Kayak, Eskimo, 2
- Kite, Airplane, 2
- Kitchen Alcove, 1, 2, 6
- Kitchen Cabinet, 1, 2, 6
- Kitchen Cupboard, 1, 2, 4, 6
- Kitchen Table, 1, 2
- Kite, Box, 5, 8
- Ladder, Gymnasium, 2
- Ladder, Step, 3
- Lamp, Aladdin, 2
- Lamp, Antique Star, 2
- Lamp, Boudoir, 7
- Lamp, Sun, 2
- Lamp, Table, 1, 2, 3
- Lathe, 2
- Lattice Work, 1, 2, 3, 4, 5
- Lawn Swing, 3, 7
- Lawn Table, 3
- Letter Rack, 5
- Lighting Fixtures, 2
- Linen Closet, 5
- Live-Bait Box, 5

Mail Box, 5	Screen-Grid Set, 1
Magazine Racks, 1, 3, 4, 5, 8	Screens, House, 3
Medicine Closet, 2	Scroll Saw, Power, 2
Merry-Go-Round, 7	Sea-Plane Model, 1, 8
Mirror Frames, 1, 4	Sedan Chair, Model, 1
Mitre Board, 2, 5	See-Saw, Merry-Go-Round, 2, 5
Model Gliders, 8	Serving Tray, 5
Model Planes, 1, 2, 3, 7, 8	Setback Cabinet, 2
Model Ships, 1, 2, 8	Sewing Cabinets, 1, 2, 3, 4
Model Schooner, 1	Sewing Screen, 4
Model Seaplane, 1, 8	Sewing Table, 1, 4
Model Sedan Chair, 1	Sheraton Chair, 4
Model Stage Coach, 1	Sheraton Desk, 4
Modernistic Book Case, 1, 2	Sheraton Table, 1
Modernistic Book Ends, 1, 3, 8	Ship Chest, 6
Modernistic Desk, 4, 8	Ship Cupboard, 4
Modernistic Lamp, 7	Ship Models, 1, 2, 8
Modernistic Screen, 1, 8	Ship Plaque, 2
Modernistic Stand, 1, 3, 8	Shoe Box-Seat, 3, 5
Modernistic Table, 4	Shoe Cabinet, 6
Nest of Tables, 4	Shutters, Window, 3
Outboard Aquaplane, 7	Skiff, Sailing, 2
Outboard Cruiser, 2	Skis, 2
Outboard Hydro-plane, 2	Skyscraper Bookcase, 7
Outboard Runabout, 2	Sled, Ice-Sailing, 2
Outdoor Gym, 3	Smoking Cabinet, 1, 2
Parallel Bars, 2	Snow Sleds, 2, 5
Pantry Shelves, 6	Snow Shoes, 2
Pergola, 1, 3	Spanish Bench, 2
Photo Statuettes, 2	Spanish Cabinet, 2
Pier Cabinet, 1, 2	Spanish Galleon, 4
Plaque, Ship, 2	Sport Plane, 7
Play House, 3, 4	Stage Coach Models, 1
Play Table, 1, 4	Stationary Cabinet, 7
Pole Screen, 7	Stand, Dynamic-Speaker, 2
Porch Chair, 1, 3	Star Lamp, 2
Porch Swing, 1	Statuettes, Photo, 2
Potting Bench, 5	Steamboat, Model, 8
Poultry House, 2	Stepladder, 3
Prisella Cabinets, 1, 2, 4, 7	Stool, Foot, 2, 3, 4, 5, 7
Rabbit Book Case, 2	Stool, Telephone, 1, 3, 4
Racing Yacht, 1, 8	Summer House, Japanese, 2
Radiator Cover, 4	Sun Dial, Pedestal, 3
Radiator Seat, 2	Surf Sleds, 8
Radio Bench, 3	Swing, Lawn, 3, 7
Radio Cabinet, 1	Swing, Venetian, 2
Runabout, Outboard, 2	Table, Bridge, 3, 4
Sailing Outfit, Canoe, 2	Table, End, 1, 3, 7
Saw Bench, 3	Table, Gateleg, 1, 3
Saw, Table for, 2	Table, Kitchen, 1, 6
Schooner, Model, 1	Table, Power Saw, 2
	Table, Sewing, 1, 4
	Table, Smoking, 4

Table, Tavern, 1	Utility Cabinet, 5
Table, Telephone, 1, 3, 4	Utility Table, 6
Table, Tilt-Top, 1, 7	Valance Boards, 2
Table Lamps, 1, 7	Vanity Case, 4
Target, Air Rifle, 2	Vanity Table, 4, 5
Tea Table, 7	Venetian Swing, 2
Tea Wagon, 1, 2, 3, 4	Wagon, Child's, 3
Telephone Cabinet, 1, 4	Wagon, Covered, Model, 1
Telephone Stool, 1, 3, 4	Wagon, Tea, 1, 2, 3, 4
Toboggan, Ski, 2	Wall Cabinet, 3
Tool Box, 1, 2, 5	Wall Desk, 5
Tool Box, Bench, 7	Wall Shelves, 1, 2, 3
Tool Cabinets, 1, 2, 3, 4, 5	Water Bob-Sled, 7
Towel Cabinet, 6	Water Scooters, 2
Towel Rack, 5	Water Wheel, 5
Toys, Wood, 1, 2, 3	Weather Vane, 1, 2, 3, 4, 5
Trapeze, Swing, 2	Welsh Dresser, 1
Treasure Chest, 1, 3	Wheelbarrow, 4, 5
Trellis, Garden, 1, 2, 3, 4, 5	Window Boxes, 2, 3
Trough, Book, 1, 2, 3, 4	Window, Refrigerator, 5
Trough, Drinking, 5	Window Screens, 3
	Window Seats, 3, 5
	Window Ventilators, 3
	Winthrop Desk, 1
	Wood Puzzles, 1, 2, 3
	Work Benches, 1, 2, 3, 4, 5, 7
	Wren Houses, 2, 3, 4, 5
	Writing Cabinet, 1, 3, 4, 7
	Yacht, Models, 1, 2, 8
	Yard Furniture, 2, 3

HOME WORKER'S BIBLIOGRAPHY

THE Publishers listed below, will gladly send full information on books, plans or periodicals for home workers, upon application. While care has been exercised to insure accuracy, we cannot assume responsibility for any prices given. Quotations on books or plans desired should be obtained direct from the publishers.

Manipulation of Tools and Wood	
Elements of Woodwork and Construction, Chas. A. King, American Book Company, Chicago, Ill.	\$1.08
Principles of Wood-working, H. Hjorth, Bruce Publishing Co., Milwaukee, Wisc.	1.76
Handwork in Wood, William Noyes, Manual Arts Press, Peoria, Ill.	3.85
Essentials of Woodworking, Ira S. Griffiths, Manual Arts Press, Peoria, Ill.	1.25
100 Problems in Woodwork, W. A. Devette, Bruce Publishing Co., Milwaukee, Wisc.	2.00
Coping Saw Work, E. F. Worst, Bruce Publishing Co., Milwaukee, Wisc.	2.40
Furniture Making	
Projects in Furniture Making, F. A. Adams, Bruce Publishing Co., Milwaukee, Wisc.	\$1.45
Built-in Furniture, Popular Mechanics, Chicago, Ill.	2.50
Furniture Making, I. S. Griffiths, Manual Arts Press, Peoria, Ill.	1.25

Furniture Upholstery, Emil A. Johnson, Manual Arts Press, Peoria, Ill.	1.25
Make Your Own Furniture, Popular Mechanics Press, Peoria, Ill.	1.00
Wood Finishing, H. R. Jeffrey, Manual Arts Press, Peoria, Ill.	1.50
Reproduction of Antique Furniture, Herman Hjorth, Bruce Publishing Co., Milwaukee, Wisc.	3.50
Carpentry	
How to Judge a House, U. S. Department of Commerce, Washington, D. C.10
Practical Wood Carving, E. Rowe, Bruce Publishing Company, Milwaukee, Wisc.	1.25
A Course in Wood Turning, A. S. Milton and O. K. Wohlers, Bruce Publishing Company	1.50
Instructions in Wood Finishing, R. A. McGee and A. G. Brown, Bruce Publishing Co.	1.60
Problems in Furniture Design, J. J. Lukowitz, Bruce Publishing Company.	2.50
Problems of Artistic Wood Turning, E. W. Ensinger, Bruce Publishing Company.	1.25
Constructive Carpentry, Chas. A. King, American Book Company.84
Inside Finishing, Chas. A. King, American Book Company.96
Carpentry, Ira S. Griffiths, Manual Arts Press.	1.25
Making Things	
Home Workshop Manual, Popular Science Monthly.	5.00
Boys' Mechanics Library, Popular Mechanics, Four volumes.	8.00
Boy Birdhouse Architecture, L. H. Baxter, Bruce Publishing Company.	1.00
Make It Yourself, Popular Mechanics.	3.00

CHAPTER IX

Special Features of ATKINS Silver Steel Hand Saws

The Story of SILVER STEEL

SILVER STEEL is the invention of Mr. E. C. Atkins, the founder of E. C. ATKINS AND COMPANY. It is manufactured exclusively for ATKINS under a special secret formula. Nothing but the finest virgin ore is used, and when combined with the other expensive ingredients of the formula, the result is the finest steel ever made into saw blades—actually of as high quality as the finest RAZOR steel.

Blades Are Hand Smithed

All SILVER STEEL Saws are smithed by hand. This is a vitally important process, often slighted or even omitted in making other brands of saws. Smithing is done in the ATKINS factories only by the most skilled men, and is a process of careful hammering to remove all unevenness, so the blade will cut true to the line.

Perfection Handle for Hand Saws



Fig. 44—Showing how ATKINS Perfection Handle directs full force of stroke to cutting edge of saw, not to back of saw as with old style handle, in dotted outlines.

Gas Tempering

SILVER STEEL receives our special process of Gas Tempering, which makes the saw blade uniformly tough and hard, without being brittle. This is the reason why a SILVER STEEL Saw will hold its keen cutting edge far longer than any other, and also why it is easier to file a SILVER STEEL Saw and to make each tooth uniform.

Two-Way Taper Grinding

After tempering, the SILVER STEEL blades for ATKINS Hand Saws are cooled and then sent to the grinding room where they are two-way Taper Ground. The blade is so ground that it actually tapers (1) from tooth edge, the widest part, throughout the entire blade towards the back of saw which is the thinnest part; and (2) gradually tapers from the handle to point of the saw. See Fig. 43. The

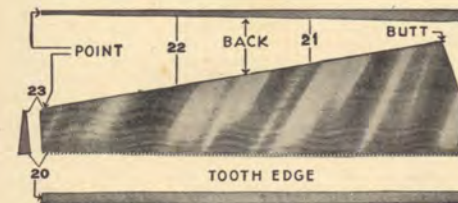


Fig. 43—Showing how ATKINS Hand Saws are Taper Ground. (Exaggerated for sake of clearness.) Figures are gauges—higher the figure, the thinner the saw.

tooth edge is of uniform thickness over entire length of blade. This two-way Taper Grinding is found only in a genuine SILVER STEEL Saw. It prevents binding or buckling and thus makes the saw run freely and easily in the cut.

With the Improved Perfection Handle, used only on the finest ATKINS Hand Saws, every ounce of power exerted by the user is directed upon the cutting edge of the blade. See Fig. 44. This type of handle eliminates wrist strain and makes every ounce of pressure count along the entire length of the cutting edge. The handle itself is a thing of beauty, being made of fine woods, handsomely carved and polished.

ATKINS also makes the old-style, straight-across handle for those who prefer this type, and it is furnished regularly on certain numbers of ATKINS Hand Saws.

Beauty of Finish

ATKINS SILVER STEEL Saws may be easily distinguished by the beauty and fineness of their polish. The famous Damaskeen and Mirror finishes were originated by ATKINS, and are used only on SILVER STEEL Saws.

Popular Patterns of Hand Saws

On the following pages, many of the most popular patterns of ATKINS Hand Saws are shown and described briefly, so that you can readily select the type of handle or style of blade you prefer.

Atkins Silver Steel Saws for Your Shop



The No. 400—Skew Back Regular

Points per inch, Cutoff, any length.....	7,	8,	9,	10,	11
Points per inch, Rip, any length.....	5 1/2				
Length, inches.....	22"	24"	26"		
Retail price, each.....	\$5.25	\$5.65	\$6.00		

No. 400—Skew Back Regular

The No. 400 Skew Back Regular Hand Saw is preferred by the critical artisan who appreciates quality in tools. The blade is of genuine SILVER STEEL, mirror polish. Taper Ground and fitted with solid rosewood handle. The handle is Atkins Improved Perfection Pattern that prevents wrist strain and gives more power on the cutting edge with less effort to the operator. Has nickel-plated screws. Made in Skew Back, regular and ship point patterns.



The No. 401—Straight Back, Ship Point

Points per inch, Cutoff, any length.....	7,	8,	9,	10,	11
Points per inch, Rip, any length.....	5 1/2				
Length, inches.....	22"	24"	26"		
Retail price, each.....	\$5.25	\$5.65	\$6.00		

No. 401—Straight Back, Ship Point

A saw of extraordinary quality, workmanship and finish. Genuine SILVER STEEL blade. FIVE gauges taper ground. MIRROR polish. Solid ROSEWOOD handle of Atkins Improved Perfection Pattern which prevents wrist strain. Nickel plated screws. Made in regular and ship pattern and straight back only.

This saw, the aristocrat of the saw world, is recommended for the critical artisan who purchases the finest tools.



Atkins No. 53—Skew Back, Regular Pattern

Points per inch, Cutoff, any length.....	7,	8,	9,	10,	11
Points per inch, Rip, any length.....	5,	5 1/2,	6		
Length, inches.....	18"	20"	22"	24"	26"
Retail price, each.....	\$2.80	\$3.10	\$3.40	\$3.60	\$3.75

No. 53—Skew Back, Regular Pattern

This saw appeals to all high-class mechanics for general carpentry and the home workshop. This is the most popular saw on the market today. The blade is of genuine SILVER STEEL, taper ground. It is given the ATKINS exclusive Damaskeen Finish. Fitted with the Atkins Improved Perfection handle of applewood, embossed and polished, which prevents wrist strain. Made in both regular and ship patterns.



Atkins No. 65—Straight Back, Ship Point

Points per inch, Cutoff, any length.....	7,	8,	9,	10,	11
Points per inch, Rip, any length.....	5,	5 1/2,	6		
Length, inches.....	18"	20"	22"	24"	26"
Retail price, each.....	\$2.80	\$3.10	\$3.40	\$3.60	\$3.75

No. 65—Straight Back, Ship Point

This is another of our most popular pattern saws for the home workshop mechanic; the companion saw to No. 53, excepting the straight back. SILVER STEEL, Damaskeen finish, embossed and polished applewood handle. Improved Perfection Pattern prevents wrist strain. Made in both regular and ship patterns.



Atkins No. 51—Skew Back, Regular Pattern

Points per inch, Cutoff, any length.....	7,	8,	9,	10,	11
Points per inch, Rip, any length.....	4 1/2,	5,	5 1/2		
Length, inches.....	18"	20"	22"	24"	26"
Retail price, each.....	\$2.80	\$3.10	\$3.40	\$3.60	\$3.75

No. 51—Skew Back, Regular Pattern

This saw is similar to No. 53 in general specifications, excepting that it is fitted with a straight across pattern handle of applewood, highly polished; has four nickel-plated screws and medallion. Recommended for the home craftsman. Made in both regular and ship patterns.



Atkins Junior Mechanic Hand Saw

This saw is made of genuine SILVER STEEL. Skew back, taper ground blade, highly polished and beautifully etched. Beech handle, coffee stained, full carved, with two nickel-plated screws and a medallion. This is a high grade home workshop saw for the young or older amateur mechanic desiring a small, light saw. Packed in attractive individual boxes.

Points per inch, Cutoff.....	9
Length, inches.....	20"
Retail price, each.....	\$2.40



Atkins No. 2—Back Saw

ATKINS No. 2 Back Saw is made of genuine SILVER STEEL and fitted with an applewood handle, handsomely lacquered. The handle is fastened to the blade with two brass screws, and medallion. The back is made of first quality blue steel, pressed on back of blade, making it stiff and rigid. This saw is used for fine work where a larger saw is not practical.

Points per inch, any length.....	14
Length, inches.....	8" 10" 12" 14" 16"
Retail price, each.....	\$2.20 \$2.40 \$2.70 \$3.05 \$3.40



Atkins No. 2—Compass Saw

The blade is made of SILVER STEEL, specially tempered, filed and set. The handle is of carved and polished applewood, attached with one saw screw and medallion. This saw is of extra fine quality and will stand a great deal of hard usage.

Points per inch, any length.....	8
Length, inches.....	10" 12" 14" 16"
Retail price, each.....	\$.80 \$.85 \$.90 \$.95



Atkins No. 1 Mitre Box Saw

In the manufacture of this saw we use genuine ATKINS SILVER STEEL. The back is of extra heavy spring steel, clamped in place to hold the blade rigid. The handle is of applewood with polished edge. Made either 4, 5, or 6 inches under back.

Points per inch.....	18" 12 pts. 20" to 32" 11 pts.
Length, inches.....	18" 20" 22" 24" 26" 28" 30" 32"
Retail price, each, width under back 4"	\$3.65 \$3.95 \$4.35 \$4.60 \$4.95 \$5.35 \$5.60 \$5.95
Retail price, each, width under back 5"	\$4.75 \$5.20 \$5.60 \$6.00 \$6.35 \$6.85
Retail price, each, width under back 6"	\$5.20 \$5.60 \$6.15 \$6.65 \$7.15 \$9.25



Atkins No. 11—Adjustable Compass Saw

Here is a SILVER STEEL Compass saw that will be found most convenient for general use. The blade is notched to fit into an adjustable handle at various angles. This saw is necessary in every home workshop set of tools.

Points per inch, any length.....	8
Length, inches.....	10" 12" 14" 16"
Retail price, each.....	\$.80 \$.85 \$.90 \$.95



Atkins No. 100—Flooring Saw

Designed for sawing into flat surfaces, such as floors, without necessity of boring or using chisel. The point is toothed on both edges so that out-of-the-way spots may be reached with ease. Made of ATKINS SILVER STEEL, beautifully polished and etched. Applewood handle, highly polished, specially designed. Has two saw screws and one medallion.

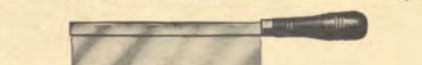
Points per inch.....	10
Length, inches.....	18"
Retail price, each.....	\$2.55



Atkins No. 6—Keyhole Saw

The finest keyhole saw in the world. SILVER STEEL adapts itself to this class of saw most admirably. Because of its extreme toughness, the blade holds its sharp cutting edge and is not easily broken. Especially adapted for home workshop owner's kit. Applewood handle, varnished and polished edges. Blade fastened to handle with saw screw and medallion.

Points per inch, any length.....	10
Length, inches.....	10" 12"
Retail price, each.....	\$.45 \$.50



Atkins No. 25—Dovetail Saw

This saw is made for light, fine work and in our famous SILVER STEEL quality only. The steel back makes it rigid and strong, yet very light. They are recommended for fine cabinet work where a Back Saw is not practical. These saws are 1 1/2 inches wide under the back. Hardwood handle.

Points per inch, any length.....	17
Length, inches.....	6" 8" 10" 12"
Retail price, each.....	\$1.35 \$1.45 \$1.60 \$1.75



Atkins No. 3—Nest of Saws

ATKINS No. 3 Nest of Saws contains a SILVER STEEL keyhole and compass blade; also an 18-inch special nail-cutting blade. When nails or other metals are encountered, you may easily cut through the metal with the nail-cutting blade and proceed with your regular hand saw. Roomy adjustable pattern handle.

Length, inches, Keyhole Blade.....	10"
Length, inches, Compass Blade.....	14"
Length, inches, Nail Cutting Blade.....	18"
Retail price, per set.....	\$2.40



Atkins No. 50—Coping Saw

A strictly high-grade tool for the critical artisan; strong, durable, and efficient. Frame 3/8-inch wide, 1/8-inch thick; made of cold-rolled steel, nicked and buffed, 7/16x4 1/8 inches deep. Blade cuts at any angle. Frame fastened to the handle by malleable iron threaded ferrule; handle strong and rigid.

Retail price, each.....	\$.60
-------------------------	--------



Atkins No. 0—Scraper Blades

SILVER STEEL is admirably adapted for this purpose and the craftsman will find it the best scraper blade he has ever used. Atkins Cabinet Scrapers are far superior in edge holding qualities to those ordinarily used. Fully appreciated by the mechanic accustomed to using fine tools. Each blade packed in wax paper cartons.

Standard sizes—

Size	Price per Dozen	Size	Price per Dozen
2 "x4"	\$.25	4 "5"	\$.50
2 1/2 "x4"	.30	4 1/2 "x5"	.55
3 "x4"	.35	2 "x6"	.35
3 1/2 "x4"	.40	2 1/2 "x6"	.35
4 "x4"	.45	3 "x6"	.40
2 "x5"	.30	3 1/2 "x6"	.55
2 1/2 "x5"	.35	4 "x6"	.55
3 "x5"	.35	4 1/2 "x6"	.60
3 1/2 "x5"	.40	5 "x6"	.65



Atkins No. 4—Rams Horn Floor Scraper

Hardwood frame, varnished and smoothly polished; it fits the hand and will not chatter.

Size of blade.....3 1/2"x3". Overall 12"
Retail price, each.....\$1.65



Atkins No. 5—Floor Scraper

Made of solid metal, 11 inches long. Two thumb-screws hold blade securely in place. Center thumb-screw presses blade into convex form to hug the work closely. SILVER STEEL Blade, beveled edges. Extra fine japanned finish.

Size of blade.....2 3/8"x2 1/2"
Retail price, each.....\$1.25



Atkins "AAA" Saw Clamp No. 2

Atkins "AAA" Saw Clamp holds the saw by an eccentric roller running between the two connecting arches instead of thumbscrews. When pressure is applied to blade, it is held securely, and will not chatter. Attached by wood screw or loose lug. This Saw Clamp is practically indispensable in a well equipped home workshop.

Retail price, each.....\$2.00



Atkins "AAA" Saw Vise

The principal advantages lie in its easy adjustment, strong construction and satisfactory service. A slight pressure on the outer jaw holds the saw firmly in place. This vise operates on the lock lever principle, which prevents overstraining as in the case where the screw is used. The jaws are lined with rubber which makes them noiseless. Made of best malleable iron, finely finished in black enamel.

Retail price, each.....\$1.45

Atkins No. 15—"AAA" Hand Saw Jointer

(Illustrated in Fig. 46 on page 29)

Atkins "AAA" Hand Saw Jointer is an essential tool in filing hand, rip, and panel saws. Its use adds to the efficiency of the saw by making the teeth uniform in length. This is a practical tool for the home workshop owner who appreciates accurately fitted Hand, Rip and Panel Saws.

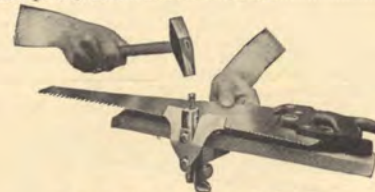
Retail price, each.....\$.20



Atkins No. 395—Saw Set

Atkins No. 395 Saw Set has a revolving anvil with indicator dial. Lever placed below the body of set. Gauge screw has check nut, which prevents it from coming loose. The revolving anvil gives the required bevel and depth of set of teeth from 4 to 16 teeth per inch. Hardened anvil and plunger. Finely tempered steel spring. Nickel plated.

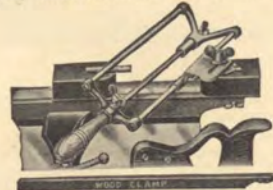
Retail price, each.....\$1.50



Atkins "AAA" Saw Set No. 5

Atkins "AAA" No. 5 Saw Sets are of high quality plunger type, used for Hand Saw setting which has many advantages over other sets of this type. They not only prevent breaking of the teeth, but assure absolute uniform set and avoid the possibility of setting the teeth too far down on the blade. A hammer blow reaches the tooth through a plunger. Amount of set easily and accurately adjusted. A very practical tool for the home workshop owner.

Retail price, each.....\$2.30



Atkins No. 8—Hand Saw Filer

Atkins No. 8 Hand Saw Filer. This saw filing device is the most perfect tool for the purpose ever produced. By the following directions the most inexperienced boy can file a saw correctly, bringing each tooth to the same bevel and pitch. It can be used with wood clamp in an ordinary vise or with an iron saw clamp. A favorite with home workshop owners.

Retail price, each.....\$2.70

Atkins Grinding Wheels

Atkins ACROLITE Grinding Wheels are made of Crystalline Alumina, almost as hard as the diamond for cutting hardest steel. Quicker and better than ordinary wheels for grinding wood-working tools, knives, saws, etc. All sizes and shapes; prices on request. Also, Atkins FERROLITE Wheels for grinding cast iron, copper, bronze, etc.

Diameter, inches8"—1 1/2" thick
Retail price, each.....\$1.70



Atkins No. 2—Solid Tooth Circular Rip Saw

This Saw is especially designed for ripping; flat ground; 18 gauge; made in standard sizes for all portable and bench machines; furnished filed and set. Atkins SILVER STEEL Circular Saws are recommended for your workshop.

Diameter, inches6" 8"
Gauge18 18
Hole3/4" 7/8"
Retail price, each.....\$2.08 \$2.77



Atkins No. 8—Solid Tooth Circular Cutoff Saw

This pattern is SILVER STEEL designed for cutting across the grain. We carry a stock in all standard sizes for portable and bench machines. Furnished filed and set. A home workshop necessity.

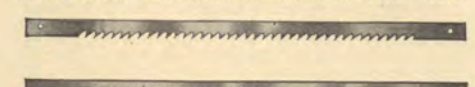
Diameter, inches6" 8"
Gauge18 18
Hole3/4" 7/8"
Retail price, each.....\$2.08 \$2.77



Atkins No. 7—Solid Tooth Combination Circular Saw

This Atkins SILVER STEEL Saw when properly fitted, both crosscuts and rips. Made of Atkins genuine SILVER STEEL; flat ground; 18 gauge; furnished filed and set. You need this combination Saw for your outfit.

Diameter, inches6" 8"
Gauge18 18
Hole3/4" 7/8"
Retail price, each.....\$2.08 \$2.77



Atkins "Jig" and Scroll Saws

Atkins Felloe Webs and Fay's Patent Scroll Saw Blades are unexcelled for fast, fine cutting on Jig Saw Machine. Made of SILVER STEEL, in lengths ranging from 1/8" to 1".

Length, inches6" 8"
Retail price, each.....\$.15 \$.15



Atkins No. 37—Mitre Saw

Atkins No. 37 Mitre Saws are most efficient where a smooth cut is desired. The first cleaner tooth on this circular mitre saw is bevel filed alternately in each section. Mitre Saws are special hollow ground to run without set, for smooth cutting, as in furniture factories and fine cabinet work. Highly recommended for the home workshop. Made in standard sizes and carried in stock for all portable and bench machines.

Diameter, inches6" 8"
Retail price, each.....\$3.40 \$4.28



Atkins Dado Heads or Groovers

Atkins Dado Heads are made from genuine SILVER STEEL. They have a capacity for cutting any width groove from 1/8-inch to 4 inches, and can be made to cut wider grooves if necessary. Atkins Dado Heads are made in six different combination sets, each set consisting of two outside saws, each of which is a groover in itself. They are furnished with as many inside cutters as the width of desired maximum groove requires. The inside cutters are made from 1/8-inch to 1/4-inch thick. The outside cutters are 1/2-inch thick. It will cut a perfect groove, either with or across the grain with an exceedingly smooth, even cut. All standard sizes carried in stock, fitted ready for use.

No. 2 set to cut to 5/8" wide.
Diameter, inches6" 8"
Retail price, each.....\$10.39 \$13.13



Atkins Narrow Band Saws

Atkins is the oldest maker of Band Saws in the United States; consequently, the cutting-qualities, flexibility, and durability of Atkins Band Saws have been developed to the highest degree.

Our Narrow Band Saws are made with the same care and precision as our Wide Bands. We use SILVER STEEL and they are of equal quality in all respects.

The quality work produced in thousands of home workshops by use of Atkins SILVER STEEL Narrow Band Saws demonstrates their superiority over ordinary saws. Made in any length. Specify length and width in ordering.

Points per inch, any width.....3, 4, 5, 6, 7
Width1/8" 3/8" 1/4" 3/8" 1/2" 5/8" 3/4" 1"
Retail price,
Per foot091 .091 .091 .098 .105 .112 .126 .154
Brazing35 .35 .35 .35 .35 .42 .42 .49

ATKINS SILVER STEEL

Atkins Silver Steel Hack Saw Blades

Made of the same high quality steel as Atkins SILVER STEEL Saws—Atkins exclusive formula. Wonderful cutting qualities. Atkins SILVER STEEL Hand Hack Saw Blades, if used in a first-class frame, upon any specified material are guaranteed to last at least SIX TIMES as long, and to cut TWICE as fast as any alloy steel blade of the same dimensions. They will lower cost and save money. Atkins SILVER STEEL "Blue End" Hack Saw Blades are the best.

These blades can be purchased in different lengths and teeth per inch.

Length, inches	10"	12"
Teeth per inch	18-24-32	14-18-24-32
Retail price, each	\$0.30	\$0.30



Atkins Non-Breakable Hack Saw Blades

Atkins Non-Breakable Hack Saw Blades are made with the usual hard edge, but with a soft back that practically prevents breakage. They should not be confused with any so-called "flexible" blades.

The edge is tempered to insure a cutting capacity equal to all-hard blades. Therefore, while the blade will cut fully as fast and hold its cutting edge as long as the all-hard blade, the liability to break or snap off is practically eliminated.

Hand blades, all lengths, are measured center to center of holes.

These blades can be purchased in different lengths and points per inch.

Length, inches	8"	10"	12"
Teeth per inch	18-24-32	14-18-24-32	14-18-24-32
Retail price, each	\$0.10	\$0.10	\$0.10



Atkins No. 7—Hack Saw Frame

Atkins No. 7 Extension Hack Saw Frame is very strong and rigid, taking 8 to 12-inch blades. Peg on the under side of the frame fits into a series of holes on the upper or outer side. Handle turns to adjust tension. Can be set to four different angles. Nickel-plated, finely buffed and polished. Depth, 3 inches; width, 1 1/4-inch; thickness, 3/8-inch.

Selected hardwood handle, finely finished, mahogany colored. Adjustable lengths.....8" 9" 10" 11" 12" Retail price, each.....\$1.65



Atkins No. 8—Hack Saw Frame

Atkins No. 8 Hack Saw is a one-piece frame and not an extension frame as the No. 7. Very stiff and rigid. 1 1/8-inch wide, 1/8-inch thick, rounded edge, 3 inches deep. Lengths, inches 8" 9" 10" 12" Retail price, each.....\$.95 \$1.00 \$1.05 \$1.15

The No. 7 and No. 8 Hack Saw Frames are amply strong but light. They are used by many home workshop owners. Finely finished hardwood handle. Packed one in a box with blade. Length.....8", 9", 10", 12"



Atkins No. 10—Hack Saw Frame

Hard Rubber Non-Breakable Handle, "Easy Grip" pattern; hung low, thus directing entire force of stroke on a line with the cutting edge of blade. This increases the cutting power, gives the operator better control, and prevents injury to the hand should blade break. Frame of cold rolled steel 3/8-inch thick and 3/4-inch wide. Nickeled and highly polished; adjustable from 8 to 12-inch blades. Peg on frame fits into a series of holes in the outside frame, making it strong and rigid when adjusted. Depth under back to cutting edge of blade, 3 inches. This Hack Saw is highly recommended to the skilled mechanic or the modern home worker who demands a hack saw with a strong, sturdy frame. Packed one in a box with blade.

Adjustable lengths, inches.....8" 9" 10" 12" Retail price, each.....\$2.50



Atkins No. 11—Hack Saw Frame

Hard rubber, non-breakable, open grip handle. This handle gives the operator complete control of the saw at all times. Frame is made of extra high grade steel, 3/4-inch wide and 5/32-inch thick. Very strong and stiff but light. Adjustable from 8 to 12 inches. Nickeled and highly polished. Depth under back to cutting edge, 4 inches. This Hack Saw is highly recommended to the mechanic who wants a high grade, strong, sturdy frame. Packed one in a box with blade.

Adjustable lengths8" 9" 10" 11" 12" Retail price, each.....\$1.40

MACHINE KNIVES



Atkins "Blue Star" High Speed Steel Planer Knives

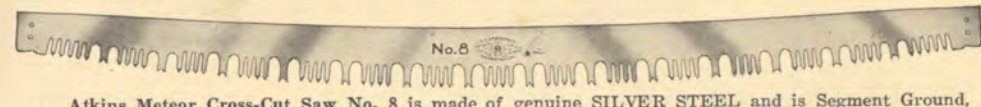
Atkins Knives are made from genuine High Speed Steel. A scientific heat treating process results in steel having toughness combined with maximum edge-holding qualities. The ability of Atkins "BLUE STAR" High Speed Steel PLANER KNIVES to do fast, clean, smooth cutting proves they have no peer on the market. Genuine Atkins "BLUE STAR" High Speed Planer Knives are absolutely dependable for the home workshop mechanic who demands accurate and smooth planer cutting. These Knives can be had in standard sizes to fit any machine. Template paper will be furnished on request. More time on the machine; less on the grinder. Data and prices on Knives for all machines sent on request.

ATKINS SILVER STEEL CROSS-CUT SAWS

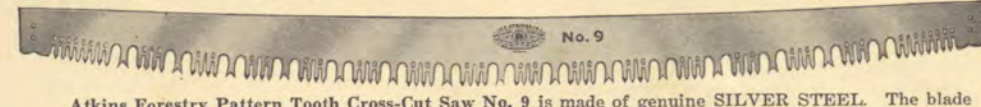
The Saw With the Blue Stick



Atkins Perfection Pattern Cross-Cut Saw No. 5 is designed for cutting yellow pine, hard woods and resinous, knotty timber. Four cutting teeth and raker. Made of SILVER STEEL, Segment Ground. 14x20x17 gauge. Very hard, tough temper, easy to file. Holds its cutting edge, and cuts fast, free and easy. 6 1/4 to 8 1/4 inches wide at center. 3 1/4 inches wide at ends. Lengths, feet 5' 5 1/2' 6' Retail price, each..... \$6.50 \$7.20 \$8.40



Atkins Meteor Cross-Cut Saw No. 8 is made of genuine SILVER STEEL and is Segment Ground. 14x16x17 gauge, which enables it to be operated easily with very little set. Teeth and rakers have heavy base, making them very strong. Highly polished and etched. The SILVER STEEL used in this saw is noted for its long edge holding qualities. 3 1/4" wide at ends and 5" wide at center. Lengths, feet 5' 5 1/2' 6' Retail price, each..... \$6.50 \$7.20 \$8.40



Atkins Forestry Pattern Tooth Cross-Cut Saw No. 9 is made of genuine SILVER STEEL. The blade is Segment Ground. 14x16x18 gauge, that prevents binding. The saw has highly polished surfaces which result in faster and easier cutting. Requires very little set. Lightweight, yet stiff enough for hard work. 3 1/4" wide at ends, 5" wide at center. Etched with Atkins trademark and name. Lengths, feet 5' 5 1/2' 6' Retail price, each..... \$6.50 \$7.20 \$8.40



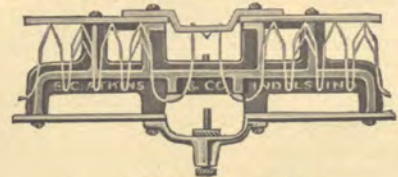
Atkins Pacific Coast Pattern SILVER STEEL Cross-Cut Saw No. 51 is used exclusively on the Pacific Coast for fir, western pine and similar woods, and especially where fast easy cutting is desired. Blade is made of genuine SILVER STEEL, Segment Ground, 13x15x17 gauge. Extra long sharp tooth with large roomy, polished gullets. Width at center 7 1/2", at ends 4 1/2". The saw that won the championship contest. Lengths, feet 5' 5 1/2' 6' Retail price, each \$10.65 \$12.00 \$13.55



Atkins Silver Steel One-Man Cross-Cut Saw No. 389 Blade is made of genuine Atkins SILVER STEEL. Tooth edge of even thickness. Blade gradually tapers toward the point on the back, Taper Ground, 15x19x17 gauge. Two cutting teeth and a raker. Made in skew back pattern. Handle finely carved and varnished on edge. Lengths, feet 3' 3 1/2' 4' Retail price, each.....\$4.25 \$5.00 \$5.70



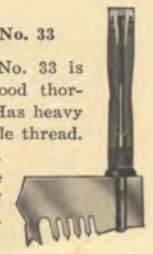
Atkins Silver Steel One-Man Cross-Cut Saw No. 390 Made of genuine SILVER STEEL, finely polished, taper ground, 15x19x17 gauge, to run free and easy. Tuttle Tooth. Fitted with hardwood handle. Polished on edges. Large roomy grip; permits user to wear heavy gloves. Lengths, feet 3' 3 1/2' 4' Retail price, each.....\$3.15 \$3.70 \$4.20



Atkins Saw Tool No. 9 Atkins AAA Saw Tool No. 9 is the best saw tool for fitting Cross-Cut Saws. It is 7" long and 1 3/8" wide. Made of the best material and very strong. This tool can be used as jointer, raker gauge, tooth set gauge, and side file. Packed in handsome box with directions for use. The ideal tool for fitting your saw. Retail price, each.....\$1.20

Atkins Cross-Cut Saw Handle No. 33

Atkins Cross-Cut Saw Handle No. 33 is made of specially selected hardwood thoroughly seasoned and kiln dried. Has heavy solid steel bolt with quick detachable thread. Has heavy steel and fibre washer. Will not wear or break. The handle is 7" long irrespective of loop. The ideal handle for practical sawyers. Length, inches7" Retail price, per pair.....\$1.10



ATKINS SILVER STEEL FILES

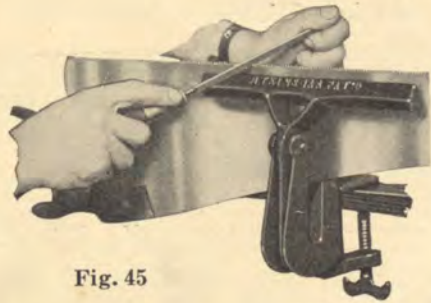


Fig. 45

A complete assortment of GOOD files is a real necessity in a well-equipped home workshop, to use for a wide variety of purposes, such as sharpening saws and other cutting tools, finishing metal edges, sizing stock, filing keyways, enlarging holes or slots, cutting curves, filing wood, etc.

SILVER STEEL is ideal for use in files—as in saws—because it takes the special hardening process better than any other steel used in making files. Files made of this steel cut faster with less effort, because the sharp hard teeth take hold of the metal and cut it away rapidly and smoothly. And these files last longer, because the teeth are unusually tough and wear down slowly and uniformly.

ATKINS makes a complete line of SILVER STEEL Files to serve every filing purpose. On this page are shown the most popular types for use in connection with home shop activities.



Mill Bastard File

Atkins SILVER STEEL Mill Bastard Files are the most generally used of any file for a greater variety of work in many machine and home workshops.

Length, inches..... 3" 4" 5" 6" 7" 8" 9" 10"
Retail price, each.. \$.15 \$.15 \$.15 \$.20 \$.20 \$.20 \$.25 \$.25



Flat Bastard File

Atkins SILVER STEEL Flat Bastard Files are commonly used in home workshops. The quality is beyond question.

Length, inches..... 4" 5" 6" 7" 8" 9" 10"
Retail price each \$.20 \$.20 \$.20 \$.25 \$.25 \$.30 \$.35



Slim Taper File

Atkins SILVER STEEL Slim Taper Files for saw filing are as accurate as brains and skill can produce. Atkins SILVER STEEL Files will outlast files the same size of other brands.

Length, inches..... 3" 4" 5" 6" 7" 8"
Retail price, each.... \$.10 \$.10 \$.10 \$.15 \$.20 \$.20



Half-Round Bastard File

Atkins SILVER STEEL Half-Round Bastard and Half-Round Smooth Files are made for general machine shop work. The quality of work and length of service obtained is superior to any other make of Half-Round files.

Length, inches..... 4" 5" 6" 7" 8"
Retail price, each..... \$.20 \$.25 \$.30 \$.35 \$.35



Half-Round Wood Rasp

Atkins SILVER STEEL Half-Round Wood Rasp Files are of remarkable efficiency due to the quality of workmanship. A favorite among home workshop owners.

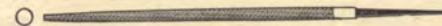
Length, inches..... 8" 10" 12"
Retail price, each..... \$.50 \$.90 \$.95



Tapered Knife File

Atkins SILVER STEEL Knife Files are of high quality finely tapered, thick on the back, taper to edge on front forming a wedge shape file.

Length, inches..... 4" 5" 6" 8" 10"
Retail price, each..... \$.25 \$.30 \$.35 \$.40 \$.50



Round File

Atkins SILVER STEEL Round Files are commonly used for all kinds of machine shop work. This file is very useful in home workshops.

Length, inches.... 4" 5" 6" 7" 8" 9" 10"
Retail price, each \$.15 \$.15 \$.15 \$.20 \$.20 \$.25 \$.25



"Hand Saw Special" File

Atkins SILVER STEEL "Hand Saw Special" Files are preferred by expert mechanics for filing hand and small saws.

Length, inches..... 5 1/2" 7" 8"
Retail price, each..... \$.15 \$.20 \$.20

Atkins Carpenter Aprons

ATKINS Carpenter Apron, made of extra heavy duck material has folded edges, strongly sewed with wide neck strap and has extra long web strings, strongly stitched to the apron.

It has two large pockets, triple stitched and bound on the edges, for nails and a pocket for a rule and pencil. ATKINS Carpenter Pencil furnished with each apron.

Retail price, each.....\$.25



CHAPTER X

HOW TO SHARPEN SAWS

THERE is only one simple rule for success with saws—"Buy GOOD saws and treat them right." Keeping this rule pays in every way. Your efforts will turn out better, you'll get far greater pleasure from your work, and you'll spend much less per year for saws.

By all means keep your saws sharp. Sharpening a saw is not the difficult job many men suppose, but it can be done readily, if a few simple and essential points are observed.

Jointing a Hand Saw

As the hand saw is the most frequently used in the shop, it will be the best example to use in illustrating the principles of sharpening saws.

The first operation is called jointing, which simply means filing the tops of the teeth to make them all level. It is not necessary to joint a saw EVERY time it is sharpened; only if the teeth are noticeably uneven and out of shape.

To joint the saw, place it in the clamp



Fig. 46

as shown in Fig. 46, and pass the file lightly over the tops of the teeth until the file touches every tooth; joint until the shortest tooth is touched lightly. All the teeth will then be of even height.

The ATKINS Saw Jointer, shown on page 25, is a handy tool to do jointing quickly and accurately.

Shaping the Teeth

After the saw has been jointed, the teeth must be filed to uniform size and shape. The teeth of a CROSS-CUT hand saw should be shaped as shown in Fig. 47,

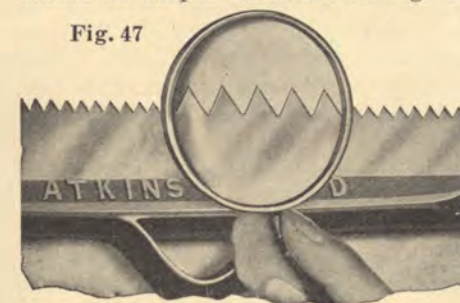


Fig. 47

which shows Cross-Cut teeth ready to set.

To shape the teeth, place the file in the

bottom of the gullet and file straight down into the blade until the finished side of the tooth is up to a point, and the flat top of the next tooth on the other side of the file is cut to the center.

Then go on to the next gullet, finishing one tooth and dividing the next as before, and continue along the entire length of the blade. Be sure to file SQUARELY across the saw, and hold your file level. Do not attempt to bevel the teeth during shaping; this comes later.



Fig. 48

When shaped the teeth of a Rip Saw should look like Fig. 48.

Setting the Teeth

Saws that are straight, level and properly ground, like ATKINS Silver Steel Saws, require very little set, because the blade is of uniform thickness along the entire tooth edge, and tapers off to the back and also tapers from the handle to point. This two-way tapering gives most of the clearance needed to let the blade run freely in the cut, and only a little set in the teeth is needed. The teeth of a saw, whether Cross-Cut or Rip type, to clear properly, should be bent outward alternately from 3/1000" to 5/1000" along the entire cutting edge, so the saw will cut a kerf slightly wider than the thickness of the blade. The degree of set in a saw depends upon the work; obviously, to cut soft, wet woods, more set is required in the saw than for sawing dry hardwoods.

Setting should not be deeper than two-thirds the distance from the point of tooth to gullet. For skilled mechanics who can use a hammer set, we recommend it as the more accurate tool for setting, but the less skilled worker should use a saw set especially designed for the purpose, as shown on page 25. Whether you use a hammer or special saw set, your saw should look when finished just like the teeth shown in Fig. 4 of a Cross-Cut hand saw and Fig. 5 of a Rip Saw on page 4.

Filing a Hand Saw

Fig. 49 shows a section of Cross-Cut Hand Saw teeth filed properly, also the

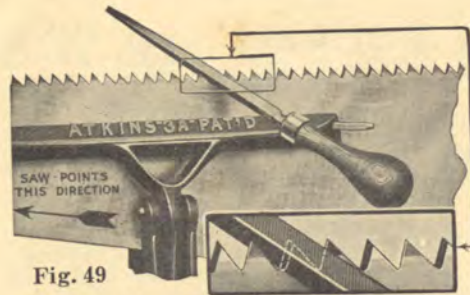


Fig. 49

position of the file. Place the saw in a vise with the handle to the right. The vise should grip the saw from $\frac{1}{8}$ " to $\frac{1}{4}$ " below the teeth. Pass a fine file very lightly over the tops of the teeth to make what we call a "shiner," or bright top, as a guide for finishing each tooth. Start in the first gullet to the LEFT of the first tooth that is set away from you at handle, with your file in the position shown in illustration. Push the file evenly and angle it across the saw, as shown, bringing each tooth to a point, possibly leaving a trifle of the "shiner" on the tooth to the right of your file. With your file in this position you can easily watch the cut of the file as you proceed with your work. Duplicate this process in EVERY OTHER gullet straight through to the point.

Then reverse your saw in the clamp, placing the handle to the left and proceed in exactly the same manner as before, except start in the first gullet to the RIGHT of the first tooth set away from you. File each tooth to a sharp point. Your

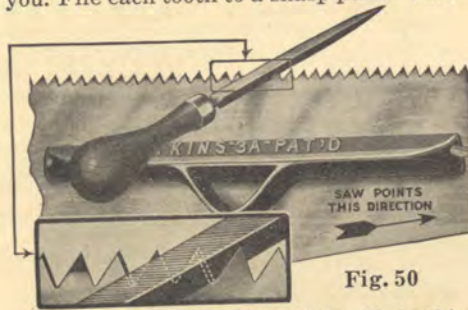


Fig. 50

position and the position of the file in this operation should be as shown in Fig. 50.

When your saw is finished it should look like illustration No. 4 on page 4, showing correctly filed Cross-Cut teeth of Hand Saw, top and side views. To accomplish this result we recommend the following ATKINS SILVER STEEL FILES for various sizes of teeth:

- 5-5½ pt. Cross-Cut Saw Teeth 6" or 7" Slim Taper File.
- 6-7 pt. Cross-Cut Saw Teeth 6" or 7" Slim Taper File.
- 8-9 pt. Cross-Cut Saw Teeth 7" Extra Slim Taper File.
- 10-11 pt. Cross-Cut Saw Teeth 4", 4½", 5" or 5½" Extra Slim Taper File.

Filing Rip Saws

Rip Saws are filed in exactly the same manner as Cross-Cut Saws are filed, except there is no bevel to the tooth of a Rip Saw. Therefore, the file is held straight across the saw at right angles to the blade and no bevel should be left on the teeth. A well filed Rip Saw should look like illustration No. 5 on page 4, showing top and side views. The proper ATKINS SILVER STEEL FILES to use for filing Rip Saws are as follows:

- 4 and 4½ pt. 7" Slim Taper Files.
- 5 and 5½ pt. 7" Slim Taper Files.
- 5 and 6½ pt. 6" or 7" Slim Taper Files.

If these directions are followed carefully, there should be no reason why any craftsman should have trouble in caring for his most valuable tool—the Saw.



Fig. 51—Shows Rip Saw teeth ready to file. After jointing, shaping and setting Rip Saws, the pitch in rip teeth should be as shown in this illustration.

After filing, the saw should be laid perfectly flat and a file or oil-stone passed gently over both sides of teeth to remedy any unevenness in the set of the saw, and to remove any wire edge or burr.

In filing Hand Saws or Small Saws, especially those used for cutting mitres and other fine work, it is best to set the teeth quite wide, and then side file them until there is very little set left, so that the saw will make smooth, fine cuts. This side-filing must be done before filing the bevel on the teeth.

Many types of saws used in the home shop require different treatment in sharpening, and special booklets giving instructions for filing the various types of ATKINS Saws are available to readers upon request to E. C. ATKINS AND COMPANY, Indianapolis.

OTHER ATKINS BOOKLETS

Helpful to the Home Craftsman—Sent Free!



Only three books to each reader, select the ones covering your needs.

Copies of these helpful, practical booklets will be sent gladly to home craftsmen, upon requests sent to the Advertising Dept., E. C. ATKINS and COMPANY, Indianapolis, Ind. Some of these booklets may be obtained at local hardware stores, and it is suggested that the reader first inquire at his dealer's for any booklet he may desire.

SAW SENSE—A 48-page booklet, full practical information for the carpenter, mechanic or home worker. Tells about the use and care of saws, shows many ATKINS Products, and gives helpful information.

MILL (CIRCULAR) SAWS—Shows a wide range of small circular and narrow band saws for use on shop machines; also many small tools for use with these saws. Tells about tooth patterns, best type to use, and shows sizes and prices of various saws.

DADO HEADS—Deals with power types of circular groovers to cut any width of groove from $\frac{1}{8}$ " to 4", with or across the grain, or diagonally. Shows sizes of sets and prices.

CARE OF SMALL BAND and CIRCULAR SAWS—Tells how to joint, file and set these saws;

also how to braze band saws. Every user of power saws should have a copy.

SAWS ON THE FARM—Shows the most complete line of saws for the farm, of any book ever issued. Thirty-two pages of practical information on wood or metal-cutting saws, and farm carpentry.

SAWS IN THE SHOP—A 32-page book telling all about metal-cutting, and showing how ATKINS Silver Steel Hack Saw Blades cut TWICE as fast, and last SIX times as long as any old style blades. Shows improved types of hack saw frames. A valuable book to every man who cuts metal of any kind.

PRUNING SAWS—A reliable guide to success in all kinds of pruning. Shows complete line of saws for pruning. Valuable to every man who grows fruit.

MACHINE KNIVES—Gives information on ATKINS Silver Steel Knives for a great variety of machines; many of them used in home shops.

HACK SAW BLADES—Shows how the new SILVER STEEL Blades have revolutionized hack saw practice—why they cut metal TWICE as fast and last SIX times as long as old-style blades.

CROSS-CUT SAWS—Tells all about these saws for farms and woods, shows various tooth designs, and gives instructions for filing cross-cuts.

GRINDING WHEELS—Shows sizes, shapes, prices and uses of ATKINS Grinding Wheels and power Grinders.

TABLE OF CONTENTS

	Page		Page
Assortments of tools.....	5, 6	Jointer, Hand Saw.....	24
Back Saws	23	Jointing a Hand Saw.....	29
Band Saws, narrow.....	25	"Junior Mechanic" Hand Saw.....	23
Bench, folding, for shop.....	16	Keyhole Saws	23
Bench, handy home-worker's	17	Lap Joints; Corner, Half, Plain and Splice	7, 8
Bibliography for Home Workers.....	20	Lathe for home shop.....	6
Boy's hand saw.....	23	Lists of tools for shops.....	5, 6
Books for home craftsmen.....	20, 31	Machine Knives for planers, etc.	26
Building things, 200 ideas.....	19, 20	Matched Joints; Tongue-Groove and Spline	14
Butt Joints; End, Side and Square....	7	Metal Cutting Saws.....	26
Cabinet, wall, for tools.....	18	Mitre Joints	9, 10
Carpenter Apron	28	Mitre Box Saws.....	23
Circular Saws, small.....	25	Mitre Saws, Circular	25
Clamp for filing saws.....	24	Mortise-Tenon Joints; Blind, Gained, Open, Panel, Plain, Shouldered and Wedged	10, 11
Compass Saws	23	Nail cutting blade.....	23
Coped Joints	14	Nest of Saws.....	23
Coping Saws	23	One-Man Cross-Cut Saws.....	27
Cross-Cut Circular Saws.....	25	Perfection Handle for Hand Saws....	21
Cross-Cut Hand Saws.....	22	Power Saws for Home Shops.....	25
Cross-Cut Saw Handle.....	27	Rabbet Joints	8
Cross-Cut Saws, One-Man.....	27	Ramshorn Floor Scraper.....	24
Cross-Cut Saws, Two-Man.....	27	Reference List of 200 Projects.....	19, 20
Cross-Cut Saw Tool.....	27	Rip Saws, Circular.....	25
Dado Joints	8	Rip Saws, Hand	22
Dado Heads for grooving.....	25	Saw Clamps	24
Dovetail Joints; Blind, Half Blind and Open	12	Saw Filers, Hand	24
Dovetail Saws	23	Saw Horses, How to Build.....	15
Dowel Joints	12	Saw Sets	24
Fastening Mitre Joints.....	10	Saw Vise	24
Files, how to use them.....	28	Sharpening Saws	29, 30
Files, Silver Steel.....	28	Scraper Blades	24
Filing Your Saws.....	29	Scrapers, Floor	24
Flooring Saw	23	Scroll Saw Blades.....	25
Floor Scrapers	24	Shaper Knives	26
Glued Joints	13	Setting a Hand Saw.....	29
Grinding Wheels	24	Selecting Saws and Tools.....	5, 6
Grooved Joints	8	Shaping Teeth of Hand Saw.....	29
Grooving, Saws for.....	25	Silver Steel, Story of.....	21
Hack Saw Frames and Blades.....	26	Shop Outfit, Building.....	15
Half Lap Joints; Corner, Cross, Dovetailed, End, and Splice.....	8	Spline Joint	14
Hand Saws, Cross-Cut and Rip.....	22	Starting a Home Shop.....	2
Hand Saws, How to File.....	29	Stopped Dado Joint.....	8
Hobby, the home workshop as a.....	1	Things to Build, 200.....	19, 20
Importance of good tools.....	3	Tool Box-Seat, Building a.....	16
Job plans, Where to get.....	19, 20	Tools, Lists of.....	5, 6
Jig Saw Blades.....	25	Types of Saws and Uses.....	4
Joints and how to make them 7, 8, 9, 10, 11, 12, 13, 14		Wall Tool Cabinet.....	18
Jointer or Planer Knives.....	26		



Copyrighted 1930
By E. C. ATKINS AND COMPANY
Printed in U. S. A.

E. C. ATKINS AND COMPANY

Established 1857
"The Silver Steel Saw People"

Manufacturers of Saws, Saw Tools, Machine Knives, Files and Grinding Wheels
Home Office and Factory, INDIANAPOLIS, IND.

Affiliated Canadian Company

Shurly-Dietrich-Atkins Company, Ltd.

Factory—Galt, Ontario

Branches—Montreal, Quebec, Vancouver, B. C.

Machine Knife Factory, Lancaster, N. Y.

Branches Carrying Complete Stocks in the Following Cities:

Atlanta, Ga.	Chicago, Ill.	New Orleans, La.	New York City, N. Y.	Memphis, Tenn.
Portland, Ore.	Klamath Falls, Ore.	San Francisco, Cal.	Seattle, Wash.	Paris, France

